

Metric Wire Connector Catalog

CATEGORY EDITION

Table of Contents

Catalog structure and section page index

One hole 0°	6
6 mm ²	6
10 mm ²	8
16 mm ²	11
25 mm ²	14
35 mm ²	17
50 mm ²	20
70 mm ²	23
95 mm ²	26
120 mm ²	29
150 mm ²	32
185 mm ²	35
240 mm ²	38
300 mm ²	41
400 mm ²	44
500 mm ²	46
625 mm ²	48
630 mm ²	50
One hole 45°	52
6 mm ²	52
10 mm ²	54
16 mm ²	56
25 mm ²	58
35 mm ²	60
50 mm ²	62
70 mm ²	64
95 mm ²	66
120 mm ²	68
150 mm ²	70
185 mm ²	72

Table of Contents (cont.)

Catalog structure and section page index

240 mm ²	74
300 mm ²	76
400 mm ²	78
One hole 90°	80
6 mm ²	80
10 mm ²	82
16 mm ²	84
25 mm ²	86
35 mm ²	88
50 mm ²	90
70 mm ²	92
95 mm ²	94
120 mm ²	96
150 mm ²	98
185 mm ²	100
240 mm ²	102
300 mm ²	104
400 mm ²	106
Two hole 0°	108
6 mm ²	108
10 mm ²	110
16 mm ²	112
25 mm ²	114
35 mm ²	116
50 mm ²	118
70 mm ²	120
95 mm ²	122
120 mm ²	124
150 mm ²	126
185 mm ²	128

Table of Contents (cont.)

Catalog structure and section page index

240 mm ²	130
300 mm ²	132
400 mm ²	134
500 mm ²	136
630 mm ²	138
None hole 0°	140
10 mm ²	140
16 mm ²	142
25 mm ²	144
35 mm ²	146
50 mm ²	148
70 mm ²	150
95 mm ²	152
120 mm ²	154
150 mm ²	156
185 mm ²	158
300 mm ²	160
400 mm ²	162
500 mm ²	164
630 mm ²	166
Splices	168
6 mm ²	168
10 mm ²	170
16 mm ²	172
25 mm ²	174
35 mm ²	176
50 mm ²	178
70 mm ²	180
95 mm ²	182
120 mm ²	184

Table of Contents (cont.)

Catalog structure and section page index

150 mm ²	186
185 mm ²	188
240 mm ²	190
300 mm ²	192
400 mm ²	194
500 mm ²	196
630 mm ²	198
Narrow Tongue	200
One - Hole Stand Barrel	200
KC Series Metric Terminals	202
6mm	202
10mm	204
16mm	206
25mm	208
35mm	210
50mm	212
70mm	214
95mm	216
120mm	218
150mm	220
185mm	222
240mm	224
300mm	226
400mm	228
500mm	230
630mm	232

6 mm²

Metric Wire Connector / One hole 0°

6 mm²

Metric Wire Connector / One hole 0° / 6 mm²

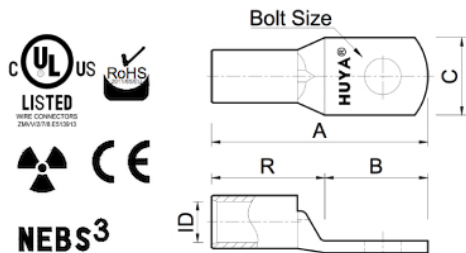

Installation Information

Manufacturer	Tools	Color	Code
T&B	TBM62	--	--
Panduit	CT-100 CT1701	--	P10
Burndy	Y10D Y10R4BY	--	--
Celestra	A45	--	--

#	Cat.No	Wire Size (mm ²)	Dimension (mm)					
			Bolt Size	A	B	C	R	ID
1	MC0603	6.00	M3	20.00	8.00	7.50	11.40	3.60
2	MC0604	6.00	M4	21.00	9.00	8.00	11.40	3.60
3	MC0604-230	6.00	M4	23.00	11.00	9.50	11.40	4.00
4	MC0605	6.00	M5	24.50	12.50	10.00	11.40	3.60
5	MC0605-230	6.00	M5	23.00	11.00	10.00	11.40	4.00
6	MC0605-240	6.00	M5	27.50	14.00	10.00	13.00	3.50
7	MC0605-250	6.00	M5	28.00	14.00	10.00	13.50	3.80
8	MC0606	6.00	M6	25.00	13.00	11.00	11.40	3.60
9	MC0606-230	6.00	M6	24.00	12.00	11.00	11.40	4.00
10	MC0606-240	6.00	M6	27.50	14.00	13.00	13.00	3.50
11	MC0606-250	6.00	M6	28.00	14.00	10.80	13.50	3.80
12	MC0608	6.00	M8	29.00	17.00	12.00	11.40	3.60
13	MC0608-230	6.00	M8	29.00	17.00	13.50	11.40	4.00
14	MC0608-240	6.00	M8	33.50	20.00	15.00	13.00	3.50
15	MC0608-250	6.00	M8	31.50	16.00	13.00	15.00	3.80
16	MC0610	6.00	M10	33.00	21.00	14.00	11.40	3.60
17	MC0610-240	6.00	M10	37.50	24.00	17.00	13.00	3.50
18	MC0612-240	6.00	M12	39.50	26.00	19.00	13.00	3.50
19	MC0635	6.00	M3.5	20.00	8.00	7.50	11.40	3.60
20	MR0605	6.00	M5	33.00	15.00	8.50	16.00	3.80
21	MR0606	6.00	M6	34.50	17.00	8.50	16.00	3.80
22	MR0608	6.00	M8	37.00	20.50	13.00	16.00	3.80

10 mm²

Metric Wire Connector / One hole 0°

10 mm²

Metric Wire Connector / One hole 0° / 10 mm²

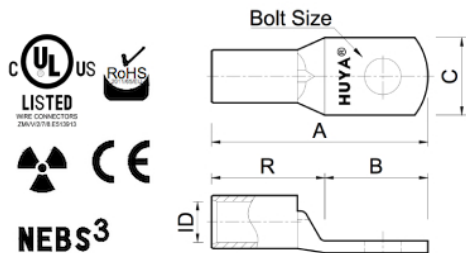

Installation Information

Manufacturer	Tools	Color	Code
T&B	TBM62 BPLT14	--	2
Panduit	CT-2001 CT-930	--	P21
Burndy	PAT600 Y35	--	49
Celestra	A45	--	2

#	Cat.No	Wire Size (mm ²)	Dimension (mm)					
			Bolt Size	A	B	C	R	ID
1	MC1004	10.00	M4	22.50	9.00	10.00	13.20	4.60
2	MC1005	10.00	M5	26.00	12.50	10.00	13.20	4.60
3	MC1005-230	10.00	M5	26.50	13.00	11.50	13.20	5.00
4	MC1005-231	10.00	M5	29.00	14.00	10.00	14.80	4.50
5	MC1005-240	10.00	M5	29.00	14.00	12.00	14.80	4.50
6	MC1005-250	10.00	M5	31.80	15.80	11.00	15.80	4.50
7	MC1005-252	10.00	M5	45.00	15.80	11.00	28.80	4.50
8	MC1006	10.00	M6	26.50	13.00	11.00	13.20	4.60
9	MC1006-230	10.00	M6	26.50	13.00	11.50	13.20	5.00
10	MC1006-231	10.00	M6	29.00	14.00	10.00	14.80	4.50
11	MC1006-240	10.00	M6	29.00	14.00	12.00	14.80	4.50
12	MC1006-250	10.00	M6	31.80	15.80	11.00	15.80	4.50
13	MC1006-252	10.00	M6	45.00	15.80	11.00	28.80	4.50
14	MC1008	10.00	M8	30.50	17.00	13.00	13.20	4.60
15	MC1008-230	10.00	M8	29.50	16.00	13.50	13.20	5.00
16	MC1008-231	10.00	M8	34.00	19.00	15.00	14.80	4.50
17	MC1008-240	10.00	M8	35.00	20.00	15.00	14.80	4.50
18	MC1008-250	10.00	M8	33.00	16.50	13.00	16.30	4.50
19	MC1008-252	10.00	M8	45.50	16.50	13.00	28.80	4.50
20	MC1010	10.00	M10	34.50	21.00	15.00	13.20	4.60
21	MC1010-230	10.00	M10	31.50	18.00	16.00	13.20	5.00
22	MC1010-231	10.00	M10	34.00	19.00	16.00	14.80	4.50
23	MC1010-240	10.00	M10	39.00	24.00	17.00	14.80	4.50
24	MC1010-250	10.00	M10	33.00	16.50	15.00	16.30	4.36
25	MC1010-252	10.00	M10	45.50	16.50	14.50	28.80	4.36
26	MC1012	10.00	M12	39.50	26.00	18.00	13.20	4.60
27	MC1012-230	10.00	M12	37.50	24.00	19.00	13.20	5.00
28	MC1012-231	10.00	M12	39.00	24.00	19.00	14.80	4.50
29	MC1012-240	10.00	M12	41.00	26.00	19.00	14.80	4.50
30	MR1005	10.00	M5	36.00	16.00	9.00	16.80	4.50

10 mm²

Metric Wire Connector / One hole 0° / 10 mm²

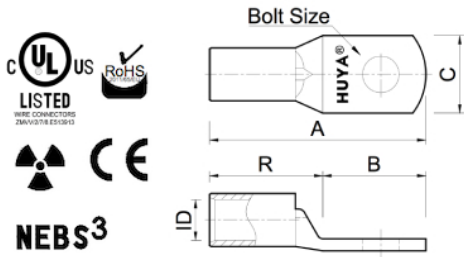

Installation Information

Manufacturer	Tools	Color	Code
T&B	TBM62 BPLT14	--	2
Panduit	CT-2001 CT-930	--	P21
Burndy	PAT600 Y35	--	49
Celestra	A45	--	2

#	Cat.No	Wire Size (mm ²)	Dimension (mm)					
			Bolt Size	A	B	C	R	ID
31	MR1006	10.00	M6	37.50	17.50	9.00	16.80	4.50
32	MR1008	10.00	M8	40.00	21.50	13.00	16.80	4.50

16 mm²

Metric Wire Connector / One hole 0°

16 mm²

Metric Wire Connector / One hole 0° / 16 mm²

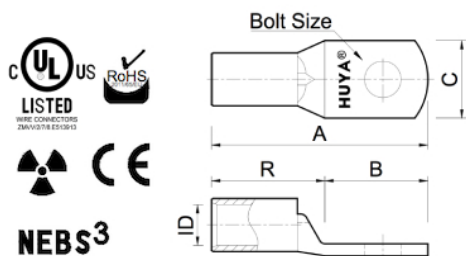

Installation Information

Manufacturer	Tools	Color	Code
T&B	TBM62 BPLT14	--	3
Panduit	CT-2001 CT-930	--	P24
Burndy	PAT600 Y35	--	7
Celestra	A45	--	3

#	Cat.No	Wire Size (mm ²)	Dimension (mm)					
			Bolt Size	A	B	C	R	ID
1	MC1604	16.00	M4	25.00	9.00	11.50	15.20	5.80
2	MC1605	16.00	M5	28.50	12.50	11.50	15.20	5.80
3	MC1605-231	16.00	M5	35.00	14.00	12.00	20.10	5.50
4	MC1605-232	16.00	M5	30.00	14.00	12.00	15.10	5.40
5	MC1605-240	16.00	M5	31.00	12.00	12.00	18.10	5.50
6	MC1605-250	16.00	M5	37.30	16.80	13.00	19.60	5.50
7	MC1605-252	16.00	M5	50.00	16.80	13.00	32.30	5.50
8	MC1606	16.00	M6	29.00	13.00	11.50	15.20	5.80
9	MC1606-230	16.00	M6	33.00	17.00	13.00	15.20	6.00
10	MC1606-231	16.00	M6	35.00	14.00	12.00	20.10	5.50
11	MC1606-232	16.00	M6	30.00	14.00	12.00	15.10	5.40
12	MC1606-240	16.00	M6	32.75	13.75	12.00	18.10	5.50
13	MC1606-250	16.00	M6	37.30	16.80	13.00	19.60	5.50
14	MC1606-252	16.00	M6	50.00	16.80	13.00	32.30	5.50
15	MC1608	16.00	M8	33.00	17.00	14.00	15.20	5.80
16	MC1608-230	16.00	M8	33.00	17.00	13.00	15.20	6.00
17	MC1608-231	16.00	M8	40.00	19.00	15.00	20.10	5.50
18	MC1608-232	16.00	M8	33.00	17.00	14.00	15.10	5.40
19	MC1608-240	16.00	M8	37.00	18.00	15.00	18.10	5.50
20	MC1608-250	16.00	M8	37.30	16.80	13.00	19.60	5.50
21	MC1608-252	16.00	M8	50.00	16.80	13.00	32.30	5.50
22	MC1610	16.00	M10	37.00	21.00	16.00	15.20	5.80
23	MC1610-230	16.00	M10	37.00	21.00	16.00	15.20	6.00
24	MC1610-231	16.00	M10	40.00	19.00	16.00	20.10	5.50
25	MC1610-232	16.00	M10	34.00	18.00	16.00	15.10	5.40
26	MC1610-240	16.00	M10	41.00	22.00	17.00	18.10	5.50
27	MC1610-250	16.00	M10	38.70	18.20	15.00	19.60	5.50
28	MC1610-252	16.00	M10	51.00	18.20	15.00	32.30	5.50
29	MC1612	16.00	M12	42.00	26.00	19.00	15.20	5.80
30	MC1612-230	16.00	M12	41.00	25.00	19.00	15.20	6.00

16 mm²

Metric Wire Connector / One hole 0° / 16 mm²

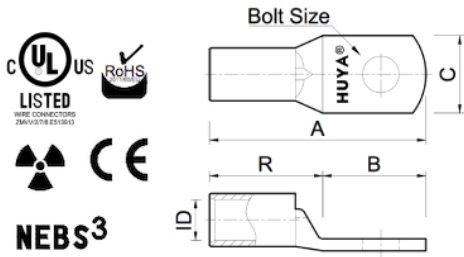

Installation Information

Manufacturer	Tools	Color	Code
T&B	TBM62 BPLT14	--	3
Panduit	CT-2001 CT-930	--	P24
Burndy	PAT600 Y35	--	7
Celestra	A45	--	3

#	Cat.No	Wire Size (mm ²)	Dimension (mm)					
			Bolt Size	A	B	C	R	ID
31	MC1612-231	16.00	M12	46.00	25.00	19.00	20.10	5.50
32	MC1612-232	16.00	M12	40.00	24.00	18.00	15.10	5.40
33	MC1612-240	16.00	M12	44.00	25.00	19.00	18.10	5.50
34	MR1606	16.00	M6	46.50	17.00	13.00	27.10	5.50
35	MR1608	16.00	M8	49.00	21.50	13.00	27.10	5.50
36	MR1610	16.00	M10	51.00	25.50	17.00	27.10	5.50
37	MR1612	16.00	M12	52.00	26.50	18.00	27.10	5.50

25 mm²

Metric Wire Connector / One hole 0°

25 mm²

Metric Wire Connector / One hole 0° / 25 mm²

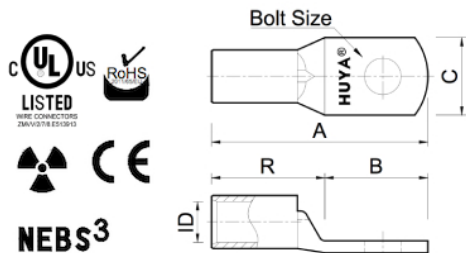

Installation Information

Manufacturer	Tools	Color	Code
T&B	TBM62 BPLT14	--	5
Panduit	CT-2001 CT-930	--	P29
Burndy	PAT600 Y35	--	9
Celestra	A45	--	5

#	Cat.No	Wire Size (mm ²)	Dimension (mm)					
			Bolt Size	A	B	C	R	ID
1	MC2504	25.00	M4	27.00	9.00	13.50	17.20	7.00
2	MC2505	25.00	M5	30.50	12.50	13.50	17.20	7.00
3	MC2505-240	25.00	M5	37.00	15.00	14.00	21.50	7.00
4	MC2506	25.00	M6	31.00	13.00	13.50	17.20	7.00
5	MC2506-230	25.00	M6	36.00	18.00	16.00	17.20	8.00
6	MC2506-231	25.00	M6	44.50	21.00	14.00	23.00	7.00
7	MC2506-232	25.00	M6	33.00	16.00	13.00	16.50	6.70
8	MC2506-240	25.00	M6	37.00	15.00	14.00	21.50	7.00
9	MC2506-250	25.00	M6	41.00	18.00	14.00	21.50	6.90
10	MC2506-252	25.00	M6	52.00	18.00	14.00	33.20	6.90
11	MC2508	25.00	M8	35.00	17.00	15.00	17.20	7.00
12	MC2508-230	25.00	M8	36.00	18.00	16.00	17.20	8.00
13	MC2508-231	25.00	M8	44.50	21.00	15.00	23.00	7.00
14	MC2508-232	25.00	M8	33.00	16.00	13.00	16.50	6.70
15	MC2508-240	25.00	M8	42.00	20.00	16.00	21.50	7.00
16	MC2508-250	25.00	M8	41.00	18.00	15.50	21.50	6.90
17	MC2508-252	25.00	M8	52.00	18.00	15.50	33.20	6.90
18	MC2510	25.00	M10	39.00	21.00	17.00	17.20	7.00
19	MC2510-230	25.00	M10	39.00	21.00	17.00	17.20	8.00
20	MC2510-231	25.00	M10	44.50	21.00	16.00	23.00	7.00
21	MC2510-232	25.00	M10	39.00	22.00	16.00	16.50	6.70
22	MC2510-240	25.00	M10	46.00	24.00	18.00	21.50	7.00
23	MC2510-250	25.00	M10	41.00	18.00	15.50	21.50	6.90
24	MC2510-252	25.00	M10	52.00	18.00	15.50	33.20	6.90
25	MC2512	25.00	M12	44.00	26.00	19.00	17.20	7.00
26	MC2512-230	25.00	M12	43.00	25.00	19.00	17.20	8.00
27	MC2512-231	25.00	M12	48.50	25.00	19.00	23.00	7.00
28	MC2512-232	25.00	M12	42.00	25.00	19.00	16.50	6.70
29	MC2512-240	25.00	M12	48.00	26.00	19.00	21.50	7.00
30	MC2514-240	25.00	M14	51.00	29.00	21.00	21.50	7.00

25 mm²

Metric Wire Connector / One hole 0° / 25 mm²

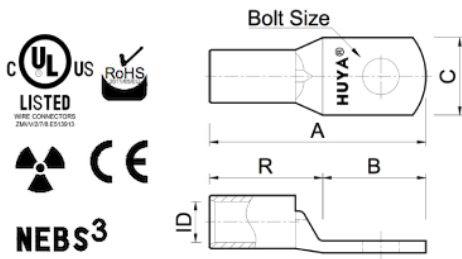

Installation Information

Manufacturer	Tools	Color	Code
T&B	TBM62 BPLT14	--	5
Panduit	CT-2001 CT-930	--	P29
Burndy	PAT600 Y35	--	9
Celestra	A45	--	5

#	Cat.No	Wire Size (mm ²)	Dimension (mm)					
			Bolt Size	A	B	C	R	ID
31	MR2506	25.00	M6	48.50	17.00	14.00	28.50	7.00
32	MR2508	25.00	M8	51.00	21.50	16.00	28.50	7.00
33	MR2510	25.00	M10	53.00	25.50	17.00	28.50	7.00
34	MR2512	25.00	M12	54.00	27.50	19.00	28.50	7.00

35 mm²

Metric Wire Connector / One hole 0°

35 mm²

Metric Wire Connector / One hole 0° / 35 mm²

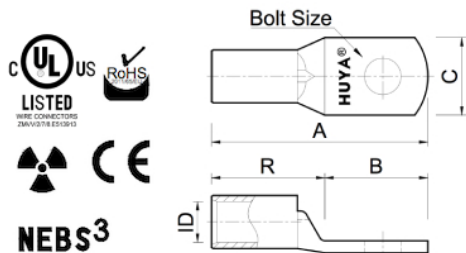

Installation Information

Manufacturer	Tools	Color	Code
T&B	TBM62 BPLT14	--	7
Panduit	CT-2001 CT-930	--	P29
Burndy	PAT600 Y35	--	10
Celestra	A45	--	7

#	Cat.No	Wire Size (mm ²)	Dimension (mm)					
			Bolt Size	A	B	C	R	ID
1	MC3505	35.00	M5	32.50	12.50	17.00	19.20	8.90
2	MC3506	35.00	M6	33.00	13.00	17.00	19.20	8.90
3	MC3506-230	35.00	M6	41.00	21.00	18.00	19.20	9.00
4	MC3506-231	35.00	M6	50.00	21.00	17.00	28.20	8.50
5	MC3506-232	35.00	M6	39.50	18.00	16.00	21.00	8.00
6	MC3506-240	35.00	M6	39.00	15.00	17.00	23.50	8.50
7	MC3506-250	35.00	M6	45.30	20.80	15.50	24.00	8.20
8	MC3506-251	35.00	M6	49.00	21.50	18.00	26.80	9.80
9	MC3506-252	35.00	M6	60.50	20.80	15.50	39.30	8.20
10	MC3508	35.00	M8	37.00	17.00	17.00	19.20	8.90
11	MC3508-230	35.00	M8	41.00	21.00	18.00	19.20	9.00
12	MC3508-231	35.00	M8	50.00	21.00	17.00	28.20	8.50
13	MC3508-232	35.00	M8	39.50	18.00	16.00	21.00	8.00
14	MC3508-240	35.00	M8	44.00	20.00	17.00	23.50	8.50
15	MC3508-250	35.00	M8	45.30	20.80	15.50	24.00	8.20
16	MC3508-251	35.00	M8	49.00	21.50	18.00	26.80	9.80
17	MC3508-252	35.00	M8	60.50	20.80	15.50	39.30	8.20
18	MC3510	35.00	M10	41.00	21.00	19.00	19.20	8.90
19	MC3510-230	35.00	M10	41.00	21.00	18.00	19.20	9.00
20	MC3510-231	35.00	M10	50.00	21.00	17.00	28.20	8.50
21	MC3510-232	35.00	M10	42.50	21.00	17.00	21.00	8.00
22	MC3510-240	35.00	M10	48.00	24.00	19.00	23.50	8.50
23	MC3510-250	35.00	M10	45.30	20.80	15.50	24.00	8.20
24	MC3510-251	35.00	M10	49.00	21.50	18.00	26.80	9.80
25	MC3510-252	35.00	M10	60.50	20.80	15.50	39.30	8.20
26	MC3512	35.00	M12	46.00	26.00	20.00	19.20	8.90
27	MC3512-230	35.00	M12	46.00	26.00	19.50	19.20	9.00
28	MC3512-231	35.00	M12	55.00	26.00	19.00	28.20	8.50
29	MC3512-232	35.00	M12	46.50	25.00	19.00	21.00	8.00
30	MC3512-240	35.00	M12	50.00	26.00	21.00	23.50	8.50

35 mm²

Metric Wire Connector / One hole 0° / 35 mm²

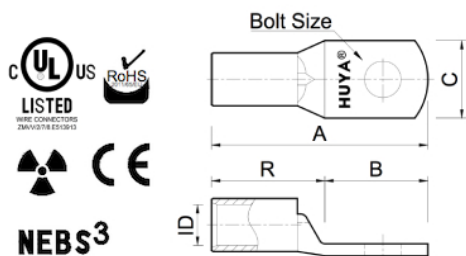

Installation Information

Manufacturer	Tools	Color	Code
T&B	TBM62 BPLT14	--	7
Panduit	CT-2001 CT-930	--	P29
Burndy	PAT600 Y35	--	10
Celestra	A45	--	7

#	Cat.No	Wire Size (mm ²)	Dimension (mm)					
			Bolt Size	A	B	C	R	ID
31	MC3512-250	35.00	M12	50.50	26.00	18.50	24.00	8.20
32	MC3512-251	35.00	M12	52.50	25.00	23.00	26.80	9.80
33	MC3512-252	35.00	M12	66.00	26.00	21.50	39.30	8.20
34	MC3514-240	35.00	M14	53.00	29.00	21.00	23.50	8.50
35	MC3516-240	35.00	M16	56.00	32.00	25.00	23.50	8.50
36	MR3506	35.00	M6	52.50	17.00	17.00	28.50	8.20
37	MR3508	35.00	M8	55.00	21.50	17.00	28.50	8.20
38	MR3510	35.00	M10	57.00	25.50	19.00	28.50	8.20
39	MR3512	35.00	M12	58.00	27.50	21.00	28.50	8.20
40	MR3514	35.00	M14	58.00	29.00	21.00	28.50	8.20

50 mm²

Metric Wire Connector / One hole 0°

50 mm²

Metric Wire Connector / One hole 0° / 50 mm²

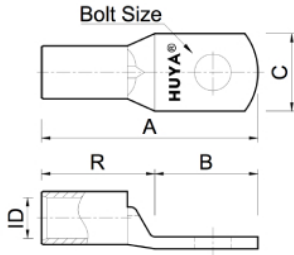

Installation Information

Manufacturer	Tools	Color	Code
T&B	TBM62 BPLT14	--	10
Panduit	CT-2001 CT-930	--	P37
Burndy	PAT600 Y35	--	12
Celestra	A45	--	10

#	Cat.No	Wire Size (mm ²)	Dimension (mm)					
			Bolt Size	A	B	C	R	ID
1	MC5006	50.00	M6	40.50	15.00	19.00	25.00	10.00
2	MC5006-230	50.00	M6	48.00	23.00	21.00	25.00	11.00
3	MC5006-231	50.00	M6	54.00	23.00	20.00	30.90	10.00
4	MC5006-232	50.00	M6	44.00	20.00	18.00	24.20	9.50
5	MC5006-240	50.00	M6	46.00	20.00	20.00	26.20	10.00
6	MC5006-250	50.00	M6	48.80	21.50	18.00	27.50	9.80
7	MC5006-251	50.00	M6	56.50	26.00	20.80	30.50	11.50
8	MC5006-252	50.00	M6	65.00	21.50	18.00	43.80	9.80
9	MC5008	50.00	M8	42.50	17.00	19.00	25.00	10.00
10	MC5008-230	50.00	M8	48.00	23.00	21.00	25.00	11.00
11	MC5008-231	50.00	M8	54.00	23.00	20.00	30.90	10.00
12	MC5008-232	50.00	M8	44.00	20.00	18.00	24.20	9.50
13	MC5008-240	50.00	M8	46.00	20.00	20.00	26.20	10.00
14	MC5008-250	50.00	M8	48.80	21.50	18.00	27.50	9.80
15	MC5008-251	50.00	M8	56.50	26.00	20.80	30.50	11.50
16	MC5008-252	50.00	M8	65.00	21.50	18.00	43.80	9.80
17	MC5010	50.00	M10	46.50	21.00	19.00	25.00	10.00
18	MC5010-230	50.00	M10	48.00	23.00	21.00	25.00	11.00
19	MC5010-231	50.00	M10	54.00	23.00	20.00	30.90	10.00
20	MC5010-232	50.00	M10	45.00	21.00	18.00	24.20	9.50
21	MC5010-240	50.00	M10	50.00	24.00	20.00	26.20	10.00
22	MC5010-250	50.00	M10	48.80	21.50	18.00	27.50	9.80
23	MC5010-251	50.00	M10	56.50	26.00	20.80	30.50	11.50
24	MC5010-252	50.00	M10	65.00	21.50	18.00	43.80	9.80
25	MC5012	50.00	M12	51.50	26.00	20.00	25.00	10.00
26	MC5012-230	50.00	M12	51.00	26.00	21.00	25.00	11.00
27	MC5012-231	50.00	M12	57.00	26.00	20.00	30.90	10.00
28	MC5012-232	50.00	M12	50.00	26.00	20.00	24.20	9.50
29	MC5012-240	50.00	M12	52.00	26.00	23.00	26.20	10.00
30	MC5012-250	50.00	M12	52.30	25.00	21.00	27.50	9.80

50 mm²

Metric Wire Connector / One hole 0° / 50 mm²

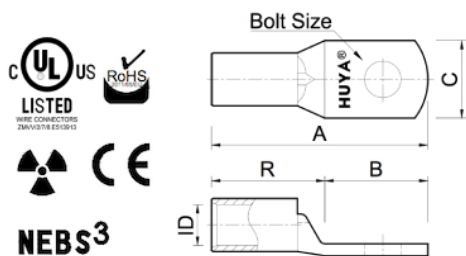

Installation Information

Manufacturer	Tools	Color	Code
T&B	TBM62 BPLT14	--	10
Panduit	CT-2001 CT-930	--	P37
Burndy	PAT600 Y35	--	12
Celestra	A45	--	10

#	Cat.No	Wire Size (mm ²)	Dimension (mm)					
			Bolt Size	A	B	C	R	ID
31	MC5012-251	50.00	M12	56.50	26.00	20.80	30.50	11.50
32	MC5012-252	50.00	M12	68.50	25.00	23.00	43.80	9.80
33	MC5014	50.00	M14	55.50	30.00	21.50	25.00	10.00
34	MC5014-240	50.00	M14	55.00	29.00	23.00	26.20	10.00
35	MC5016	50.00	M16	59.50	34.00	24.00	25.00	10.00
36	MC5016-230	50.00	M16	57.00	32.00	24.00	25.00	11.00
37	MC5016-240	50.00	M16	58.00	32.00	27.00	26.20	10.00
38	MC5020-240	50.00	M20	64.00	38.00	29.00	26.20	10.00
39	MR5008	50.00	M8	65.00	21.50	20.00	37.20	10.00
40	MR5010	50.00	M10	67.00	25.50	22.00	37.20	10.00
41	MR5012	50.00	M12	68.00	27.50	24.00	37.20	10.00
42	MR5014	50.00	M14	68.00	29.00	24.00	37.20	10.00
43	MR5016	50.00	M16	71.00	33.50	28.00	37.20	10.00

70 mm²

Metric Wire Connector / One hole 0°

70 mm²

Metric Wire Connector / One hole 0° / 70 mm²

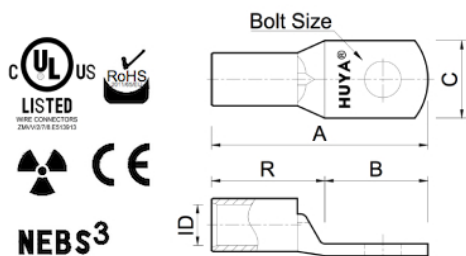

Installation Information

Manufacturer	Tools	Color	Code
T&B	TBM62 BPLT14	--	14
Panduit	CT-2001 CT-930	--	P45
Burndy	PAT600 Y35	--	13
Celestra	A45	--	14

#	Cat.No	Wire Size (mm ²)	Dimension (mm)					
			Bolt Size	A	B	C	R	ID
1	MC7006	70.00	M6	42.00	15.00	21.00	26.60	11.30
2	MC7006-230	70.00	M6	50.00	23.00	25.00	26.60	13.00
3	MC7006-240	70.00	M6	49.50	20.00	23.00	29.10	12.00
4	MC7006-250	70.00	M6	57.60	26.00	20.80	31.40	11.50
5	MC7006-251	70.00	M6	61.50	28.50	24.50	32.60	13.50
6	MC7006N	70.00	M6	42.50	15.00	11.50	26.60	11.30
7	MC7008	70.00	M8	44.00	17.00	21.00	26.60	11.30
8	MC7008-230	70.00	M8	50.00	23.00	25.00	26.60	13.00
9	MC7008-231	70.00	M8	55.50	23.00	23.00	32.50	12.00
10	MC7008-232	70.00	M8	54.50	23.00	20.50	31.10	11.30
11	MC7008-240	70.00	M8	49.50	20.00	23.00	29.10	12.00
12	MC7008-250	70.00	M8	57.60	26.00	20.80	31.40	11.50
13	MC7008-251	70.00	M8	61.50	28.50	24.50	32.60	13.50
14	MC7008-252	70.00	M8	72.50	26.00	20.80	46.10	11.50
15	MC7010	70.00	M10	48.00	21.00	21.00	26.60	11.30
16	MC7010-230	70.00	M10	50.00	23.00	25.00	26.60	13.00
17	MC7010-231	70.00	M10	55.50	23.00	23.00	32.50	12.00
18	MC7010-232	70.00	M10	54.50	23.00	20.50	31.10	11.30
19	MC7010-240	70.00	M10	53.50	24.00	23.00	29.10	12.00
20	MC7010-250	70.00	M10	57.60	26.00	20.80	31.40	11.50
21	MC7010-251	70.00	M10	61.50	28.50	24.50	32.60	13.50
22	MC7010-252	70.00	M10	72.50	26.00	20.80	46.10	11.50
23	MC7012	70.00	M12	53.00	26.00	21.00	26.60	11.30
24	MC7012-230	70.00	M12	53.00	26.00	25.00	26.60	13.00
25	MC7012-231	70.00	M12	58.50	26.00	23.00	32.50	12.00
26	MC7012-232	70.00	M12	57.50	26.00	20.50	31.10	11.30
27	MC7012-240	70.00	M12	55.50	26.00	23.00	29.10	12.00
28	MC7012-250	70.00	M12	57.60	26.00	20.80	31.40	11.50
29	MC7012-251	70.00	M12	61.50	28.50	24.50	32.60	13.50
30	MC7012-252	70.00	M12	72.50	26.00	20.80	46.10	11.50

70 mm²

Metric Wire Connector / One hole 0° / 70 mm²

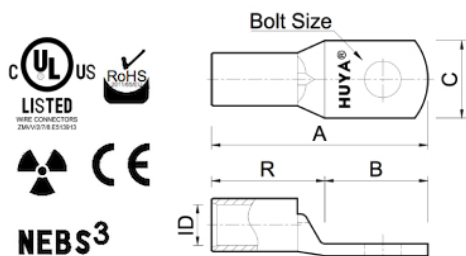

Installation Information

Manufacturer	Tools	Color	Code
T&B	TBM62 BPLT14	--	14
Panduit	CT-2001 CT-930	--	P45
Burndy	PAT600 Y35	--	13
Celestra	A45	--	14

#	Cat.No	Wire Size (mm ²)	Dimension (mm)					
			Bolt Size	A	B	C	R	ID
31	MC7014	70.00	M14	57.00	30.00	22.00	26.60	11.30
32	MC7014-240	70.00	M14	58.50	29.00	23.00	29.10	12.00
33	MC7016	70.00	M16	61.00	34.00	24.00	26.60	11.30
34	MC7016-230	70.00	M16	59.00	32.00	25.00	26.60	13.00
35	MC7016-240	70.00	M16	61.50	32.00	26.00	29.10	12.00
36	MC7020-240	70.00	M20	67.50	38.00	30.00	29.10	12.00
37	MR7008	70.00	M8	68.00	21.50	24.00	38.10	11.50
38	MR7010	70.00	M10	70.00	25.50	24.00	38.10	11.50
39	MR7012	70.00	M12	71.00	27.50	24.00	38.10	11.50
40	MR7014	70.00	M14	71.00	29.00	24.00	38.10	11.50
41	MR7016	70.00	M16	74.00	33.50	30.00	38.10	11.50

95 mm²

Metric Wire Connector / One hole 0°

95 mm²

Metric Wire Connector / One hole 0° / 95 mm²

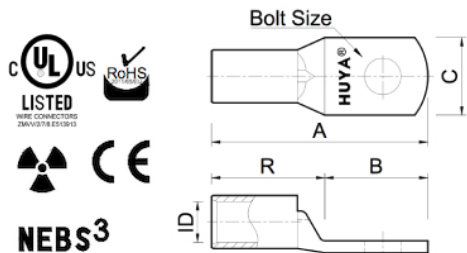

Installation Information

Manufacturer	Tools	Color	Code
T&B	TBM62 BPLT14	--	19
Panduit	CT-2001 CT-930	--	P45
Burndy	MY29 Y644M	--	14
Celestra	A45	--	19

#	Cat.No	Wire Size (mm ²)	Dimension (mm)					
			Bolt Size	A	B	C	R	ID
1	MC9506	95.00	M6	46.50	15.00	25.50	30.80	13.50
2	MC9508	95.00	M8	48.50	17.00	25.50	30.80	13.50
3	MC9508-230	95.00	M8	63.50	32.00	29.00	30.80	15.00
4	MC9508-231	95.00	M8	60.50	23.00	26.00	36.60	13.50
5	MC9508-232	95.00	M8	58.50	23.00	24.00	34.60	13.00
6	MC9508-240	95.00	M8	58.00	24.00	26.00	33.10	13.50
7	MC9508-250	95.00	M8	62.00	28.50	24.50	32.60	13.50
8	MC9508-251	95.00	M8	63.50	30.00	27.50	32.60	15.20
9	MC9508-252	95.00	M8	80.50	28.50	24.50	51.10	13.50
10	MC9510	95.00	M10	52.50	21.00	25.50	30.80	13.50
11	MC9510-230	95.00	M10	63.50	32.00	29.00	30.80	15.00
12	MC9510-231	95.00	M10	60.50	23.00	26.00	36.60	13.50
13	MC9510-232	95.00	M10	58.50	23.00	24.00	34.60	13.00
14	MC9510-240	95.00	M10	58.00	24.00	26.00	33.10	13.50
15	MC9510-250	95.00	M10	62.00	28.50	24.50	32.60	13.50
16	MC9510-251	95.00	M10	63.50	30.00	27.50	32.60	15.20
17	MC9510-252	95.00	M10	80.50	28.50	24.50	51.10	13.50
18	MC9512	95.00	M12	57.50	26.00	25.50	30.80	13.50
19	MC9512-230	95.00	M12	63.50	32.00	29.00	30.80	15.00
20	MC9512-231	95.00	M12	63.50	26.00	26.00	36.60	13.50
21	MC9512-232	95.00	M12	61.50	26.00	24.00	34.60	13.00
22	MC9512-240	95.00	M12	60.00	26.00	26.00	33.10	13.50
23	MC9512-250	95.00	M12	62.00	28.50	24.50	32.60	13.50
24	MC9512-251	95.00	M12	63.50	30.00	27.50	32.60	15.20
25	MC9512-252	95.00	M12	80.50	28.50	24.50	51.10	13.50
26	MC9514	95.00	M14	61.50	30.00	25.50	30.80	13.50
27	MC9514-240	95.00	M14	63.00	29.00	26.00	33.10	13.50
28	MC9516	95.00	M16	65.50	34.00	25.50	30.80	13.50
29	MC9516-230	95.00	M16	63.50	32.00	29.00	30.80	15.00
30	MC9516-231	95.00	M16	69.50	32.00	26.00	36.60	13.50

95 mm²

Metric Wire Connector / One hole 0° / 95 mm²

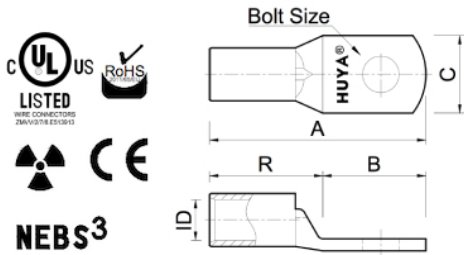

Installation Information

Manufacturer	Tools	Color	Code
T&B	TBM62 BPLT14	--	19
Panduit	CT-2001 CT-930	--	P45
Burndy	MY29 Y644M	--	14
Celestra	A45	--	19

#	Cat.No	Wire Size (mm ²)	Dimension (mm)					
			Bolt Size	A	B	C	R	ID
31	MC9516-232	95.00	M16	67.50	32.00	26.00	34.60	13.00
32	MC9516-240	95.00	M16	66.00	32.00	28.00	33.10	13.50
33	MC9516-250	95.00	M16	62.00	28.50	24.50	32.60	13.50
34	MC9516-251	95.00	M16	63.50	30.00	27.50	32.60	15.20
35	MC9516-252	95.00	M16	80.50	28.50	24.50	51.10	13.50
36	MC9520	95.00	M20	73.50	42.00	29.50	30.80	13.50
37	MC9520-240	95.00	M20	78.00	44.00	30.00	33.10	13.50
38	MR9508	95.00	M8	78.00	23.50	28.00	45.10	13.50
39	MR9510	95.00	M10	80.00	25.50	28.00	45.10	13.50
40	MR9512	95.00	M12	81.00	27.50	28.00	45.10	13.50
41	MR9514	95.00	M14	81.00	29.00	28.00	45.10	13.50
42	MR9516	95.00	M16	84.00	33.50	32.00	45.10	13.50

120 mm²

Metric Wire Connector / One hole 0°

120 mm²

Metric Wire Connector / One hole 0° / 120 mm²

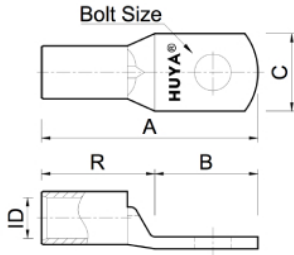

Installation Information

Manufacturer	Tools	Color	Code
T&B	TBM62 BPLT14	--	24
Panduit	CT-2001 CT-930	--	P62
Burndy	PAT600 Y35	--	15
Celestra	A45	--	24

#	Cat.No	Wire Size (mm ²)	Dimension (mm)					
			Bolt Size	A	B	C	R	ID
1	MC1206	120.00	M6	48.00	15.00	28.50	32.50	15.20
2	MC1208	120.00	M8	50.00	17.00	28.50	32.50	15.20
3	MC1208-240	120.00	M8	63.50	28.00	28.00	34.90	15.00
4	MC1208-250	120.00	M8	64.00	30.00	27.50	33.40	15.20
5	MC1208-251	120.00	M8	71.50	34.50	30.50	36.40	16.50
6	MC1208-252	120.00	M8	79.50	30.00	27.50	48.60	15.20
7	MC1210	120.00	M10	54.00	21.00	28.50	32.50	15.20
8	MC1210-230	120.00	M10	65.00	32.00	32.00	32.50	17.00
9	MC1210-231	120.00	M10	64.50	25.00	28.00	38.90	15.00
10	MC1210-232	120.00	M10	64.00	26.00	28.00	37.40	15.00
11	MC1210-240	120.00	M10	63.50	28.00	28.00	34.90	15.00
12	MC1210-250	120.00	M10	64.00	30.00	27.50	33.40	15.20
13	MC1210-251	120.00	M10	71.50	34.50	30.50	36.40	16.50
14	MC1210-252	120.00	M10	79.50	30.00	27.50	48.60	15.20
15	MC1212	120.00	M12	59.00	26.00	28.50	32.50	15.20
16	MC1212-230	120.00	M12	65.00	32.00	32.00	32.50	17.00
17	MC1212-231	120.00	M12	65.50	26.00	28.00	38.90	15.00
18	MC1212-232	120.00	M12	64.00	26.00	28.00	37.40	15.00
19	MC1212-240	120.00	M12	63.50	28.00	28.00	34.90	15.00
20	MC1212-250	120.00	M12	64.00	30.00	27.50	33.40	15.20
21	MC1212-251	120.00	M12	71.50	34.50	30.50	36.40	16.50
22	MC1212-252	120.00	M12	79.50	30.00	27.50	48.60	15.20
23	MC1214	120.00	M14	63.00	30.00	28.50	32.50	15.20
24	MC1214-240	120.00	M14	65.50	30.00	28.00	34.90	15.00
25	MC1216	120.00	M16	67.00	34.00	28.50	32.50	15.20
26	MC1216-230	120.00	M16	65.00	32.00	32.00	32.50	17.00
27	MC1216-231	120.00	M16	71.50	32.00	28.00	38.90	15.00
28	MC1216-232	120.00	M16	70.00	32.00	28.00	37.40	15.00
29	MC1216-240	120.00	M16	67.50	32.00	28.00	34.90	15.00
30	MC1216-250	120.00	M16	64.00	30.00	27.50	33.40	15.20

120 mm²

Metric Wire Connector / One hole 0° / 120 mm²

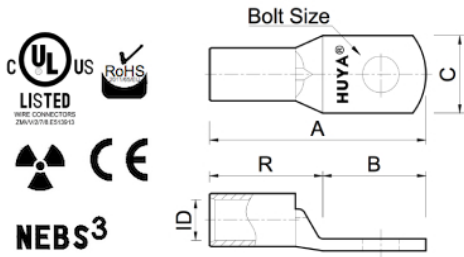

Installation Information

Manufacturer	Tools	Color	Code
T&B	TBM62 BPLT14	--	24
Panduit	CT-2001 CT-930	--	P62
Burndy	PAT600 Y35	--	15
Celestra	A45	--	24

#	Cat.No	Wire Size (mm ²)	Dimension (mm)					
			Bolt Size	A	B	C	R	ID
31	MC1216-251	120.00	M16	71.50	34.50	30.50	36.40	16.50
32	MC1216-252	120.00	M16	79.50	30.00	27.50	48.60	15.20
33	MC1220	120.00	M20	75.00	42.00	29.50	32.50	15.20
34	MC1220-240	120.00	M20	79.50	44.00	30.00	34.90	15.00
35	MR1210	120.00	M10	85.00	29.50	32.00	45.90	15.50
36	MR1212	120.00	M12	86.00	31.50	32.00	45.90	15.50
37	MR1214	120.00	M14	86.00	33.50	32.00	45.90	15.50
38	MR1216	120.00	M16	89.00	37.50	32.00	45.90	15.50
39	MR1220	120.00	M20	92.00	42.50	38.00	45.90	15.50

150 mm²

Metric Wire Connector / One hole 0°

150 mm²

Metric Wire Connector / One hole 0° / 150 mm²

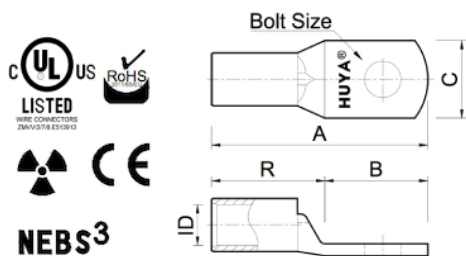

Installation Information

Manufacturer	Tools	Color	Code
T&B	TBM62 BPLT14	--	30
Panduit	CT-2001 CT-930	--	P66
Burndy	PAT600 Y35	--	17
Celestra	A45	--	30

#	Cat.No	Wire Size (mm ²)	Dimension (mm)					
			Bolt Size	A	B	C	R	ID
1	MC1508	150.00	M8	60.50	24.00	31.50	35.90	16.70
2	MC1508-240	150.00	M8	69.00	28.00	31.00	40.20	16.50
3	MC1508-250	150.00	M8	73.00	34.50	30.50	37.70	16.50
4	MC1508-251	150.00	M8	73.00	34.00	33.50	38.40	18.60
5	MC1508-252	150.00	M8	102.50	34.50	30.50	67.20	16.50
6	MC1510	150.00	M10	60.50	24.00	31.50	35.90	16.70
7	MC1510-230	150.00	M10	68.50	32.00	36.00	35.90	19.00
8	MC1510-240	150.00	M10	69.00	28.00	31.00	40.20	16.50
9	MC1510-250	150.00	M10	73.00	34.50	30.50	37.70	16.50
10	MC1510-251	150.00	M10	73.00	34.00	33.50	38.40	18.60
11	MC1510-252	150.00	M10	102.50	34.50	30.50	67.20	16.50
12	MC1512	150.00	M12	66.50	30.00	31.50	35.90	16.70
13	MC1512-230	150.00	M12	68.50	32.00	36.00	35.90	19.00
14	MC1512-231	150.00	M12	76.50	32.00	32.00	43.70	17.00
15	MC1512-232	150.00	M12	75.00	32.00	32.00	42.20	17.00
16	MC1512-240	150.00	M12	71.00	30.00	31.00	40.20	16.50
17	MC1512-250	150.00	M12	73.00	34.50	30.50	37.70	16.50
18	MC1512-251	150.00	M12	73.00	34.00	33.50	38.40	18.60
19	MC1512-252	150.00	M12	102.50	34.50	30.50	67.20	16.50
20	MC1514	150.00	M14	70.50	34.00	31.50	35.90	16.70
21	MC1514-240	150.00	M14	71.00	30.00	31.00	40.20	16.50
22	MC1516	150.00	M16	72.50	36.00	31.50	35.90	16.70
23	MC1516-230	150.00	M16	68.50	32.00	36.00	35.90	19.00
24	MC1516-231	150.00	M16	76.50	32.00	32.00	43.70	17.00
25	MC1516-232	150.00	M16	75.00	32.00	32.00	42.20	17.00
26	MC1516-240	150.00	M16	73.00	32.00	31.00	40.20	16.50
27	MC1516-250	150.00	M16	73.00	34.50	30.50	37.70	16.50
28	MC1516-251	150.00	M16	73.00	34.00	33.50	38.40	18.60
29	MC1516-252	150.00	M16	102.50	34.50	30.50	67.20	16.50
30	MC1520	150.00	M20	78.50	42.00	31.50	35.90	16.70

150 mm²

Metric Wire Connector / One hole 0° / 150 mm²

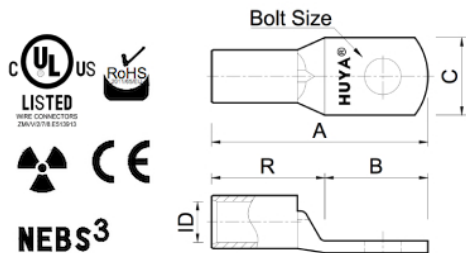

Installation Information

Manufacturer	Tools	Color	Code
T&B	TBM62 BPLT14	--	30
Panduit	CT-2001 CT-930	--	P66
Burndy	PAT600 Y35	--	17
Celestra	A45	--	30

#	Cat.No	Wire Size (mm ²)	Dimension (mm)					
			Bolt Size	A	B	C	R	ID
31	MC1520-230	150.00	M20	75.50	39.00	36.00	35.90	19.00
32	MC1520-231	150.00	M20	83.50	39.00	32.00	43.70	17.00
33	MC1520-232	150.00	M20	82.00	39.00	32.00	42.20	17.00
34	MC1520-240	150.00	M20	85.00	44.00	31.00	40.20	16.50
35	MC1520-250	150.00	M20	77.00	38.50	30.50	37.70	16.50
36	MC1520-251	150.00	M20	77.50	38.50	33.50	38.40	18.60
37	MC1520-252	150.00	M20	106.50	38.50	30.50	67.20	16.50
38	MR1510	150.00	M10	93.00	29.50	34.00	47.20	17.00
39	MR1512	150.00	M12	94.00	31.50	34.00	47.20	17.00
40	MR1514	150.00	M14	94.00	34.50	34.00	47.20	17.00
41	MR1516	150.00	M16	97.00	37.50	34.00	47.20	17.00
42	MR1520	150.00	M20	100.00	42.50	40.00	47.20	17.00

185 mm²

Metric Wire Connector / One hole 0°

185 mm²

Metric Wire Connector / One hole 0° / 185 mm²

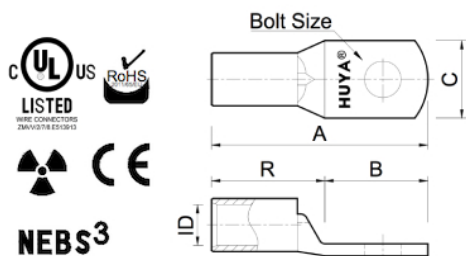

Installation Information

Manufacturer	Tools	Color	Code
T&B	TBM62 BPLT14	--	37
Panduit	CT-2001 CT-930	--	P76
Burndy	PAT600 Y35	--	18
Celestra	A45	--	37

#	Cat.No	Wire Size (mm ²)	Dimension (mm)					
			Bolt Size	A	B	C	R	ID
1	MC1808	185.00	M8	64.00	24.00	35.50	39.40	19.20
2	MC1810	185.00	M10	64.00	24.00	35.50	39.40	19.20
3	MC1810-230	185.00	M10	72.00	32.00	39.00	39.40	21.00
4	MC1810-240	185.00	M10	79.50	36.00	35.00	42.70	19.00
5	MC1810-250	185.00	M10	75.70	34.00	33.50	40.90	18.60
6	MC1810-251	185.00	M10	89.00	40.50	37.50	47.70	20.80
7	MC1810-252	185.00	M10	103.50	34.00	33.50	69.00	18.60
8	MC1812	185.00	M12	70.00	30.00	35.50	39.40	19.20
9	MC1812-230	185.00	M12	72.00	32.00	39.00	39.40	21.00
10	MC1812-231	185.00	M12	80.00	32.00	35.00	47.20	19.00
11	MC1812-232	185.00	M12	80.50	32.00	36.00	47.70	19.00
12	MC1812-240	185.00	M12	79.50	36.00	35.00	42.70	19.00
13	MC1812-250	185.00	M12	75.70	34.00	33.50	40.90	18.60
14	MC1812-251	185.00	M12	89.00	40.50	37.50	47.70	20.80
15	MC1812-252	185.00	M12	103.50	34.00	33.50	69.00	18.60
16	MC1814	185.00	M14	74.00	34.00	35.50	39.40	19.20
17	MC1814-240	185.00	M14	79.50	36.00	35.00	42.70	19.00
18	MC1816	185.00	M16	76.00	36.00	35.50	39.40	19.20
19	MC1816-230	185.00	M16	72.00	32.00	39.00	39.40	21.00
20	MC1816-231	185.00	M16	80.00	32.00	35.00	47.20	19.00
21	MC1816-232	185.00	M16	80.50	32.00	36.00	47.70	19.00
22	MC1816-240	185.00	M16	79.50	36.00	35.00	42.70	19.00
23	MC1816-250	185.00	M16	75.70	34.00	33.50	40.90	18.60
24	MC1816-251	185.00	M16	89.00	40.50	37.50	47.70	20.80
25	MC1816-252	185.00	M16	103.50	34.00	33.50	69.00	18.60
26	MC1820	185.00	M20	82.00	42.00	35.50	39.40	19.20
27	MC1820-230	185.00	M20	79.00	39.00	39.00	39.40	21.00
28	MC1820-231	185.00	M20	87.00	39.00	35.00	47.20	19.00
29	MC1820-232	185.00	M20	87.50	39.00	36.00	47.70	19.00
30	MC1820-240	185.00	M20	87.50	44.00	35.00	42.70	19.00

185 mm²

Metric Wire Connector / One hole 0° / 185 mm²

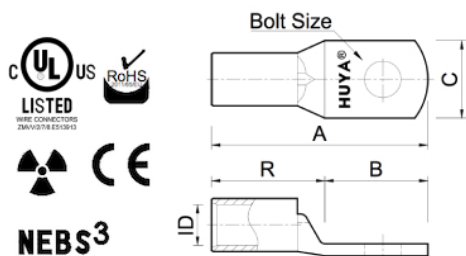

Installation Information

Manufacturer	Tools	Color	Code
T&B	TBM62 BPLT14	--	37
Panduit	CT-2001 CT-930	--	P76
Burndy	PAT600 Y35	--	18
Celestra	A45	--	37

#	Cat.No	Wire Size (mm ²)	Dimension (mm)					
			Bolt Size	A	B	C	R	ID
31	MC1820-250	185.00	M20	80.20	38.50	33.50	40.90	18.60
32	MC1820-251	185.00	M20	89.00	40.50	37.50	47.70	20.80
33	MC1820-252	185.00	M20	108.00	38.50	33.50	69.00	18.60
34	MR1810	185.00	M10	97.00	29.50	37.00	54.70	19.00
35	MR1812	185.00	M12	98.00	31.50	37.00	54.70	19.00
36	MR1814	185.00	M14	98.00	34.50	37.00	54.70	19.00
37	MR1816	185.00	M16	101.00	37.50	37.00	54.70	19.00
38	MR1820	185.00	M20	104.00	42.50	40.00	54.70	19.00

240 mm²

Metric Wire Connector / One hole 0°

240 mm²

Metric Wire Connector / One hole 0° / 240 mm²

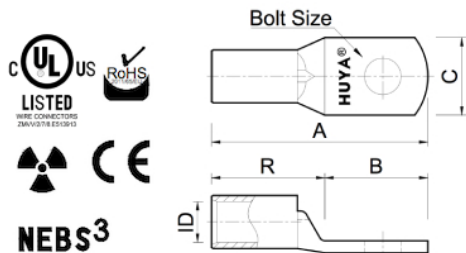

Installation Information

Manufacturer	Tools	Color	Code
T&B	TBM62 BPLT14	--	48
Panduit	CT-2001 CT-930	--	P87
Burndy	PAT600 Y35	--	20
Celestra	A45	--	48

#	Cat.No	Wire Size (mm ²)	Dimension (mm)					
			Bolt Size	A	B	C	R	ID
1	MC2408	240.00	M8	71.00	24.00	39.50	47.40	21.10
2	MC2410	240.00	M10	71.00	24.00	39.50	47.40	21.10
3	MC2410-230	240.00	M10	86.00	39.00	42.00	47.40	22.50
4	MC2410-240	240.00	M10	91.50	40.50	38.00	51.30	21.00
5	MC2410-250	240.00	M10	91.50	40.50	37.50	51.30	20.80
6	MC2410-251	240.00	M10	98.00	42.00	42.50	56.60	23.50
7	MC2410-252	240.00	M10	119.50	40.50	37.50	79.80	20.80
8	MC2412	240.00	M12	77.00	30.00	39.50	47.40	21.10
9	MC2412-230	240.00	M12	86.00	39.00	42.00	47.40	22.50
10	MC2412-231	240.00	M12	86.50	32.00	38.00	54.80	21.00
11	MC2412-232	240.00	M12	86.00	32.00	39.00	54.30	21.00
12	MC2412-240	240.00	M12	91.50	40.50	38.00	51.30	21.00
13	MC2412-250	240.00	M12	91.50	40.50	37.50	51.30	20.80
14	MC2412-251	240.00	M12	98.00	42.00	42.50	56.60	23.50
15	MC2412-252	240.00	M12	119.50	40.50	37.50	79.80	20.80
16	MC2414	240.00	M14	81.00	34.00	39.50	47.40	21.10
17	MC2414-240	240.00	M14	91.50	40.50	38.00	51.30	21.00
18	MC2416	240.00	M16	83.00	36.00	39.50	47.40	21.10
19	MC2416-230	240.00	M16	86.00	39.00	42.00	47.40	22.50
20	MC2416-231	240.00	M16	86.50	32.00	38.00	54.80	21.00
21	MC2416-232	240.00	M16	86.00	32.00	39.00	54.30	21.00
22	MC2416-240	240.00	M16	91.50	40.50	38.00	51.30	21.00
23	MC2416-250	240.00	M16	91.50	40.50	37.50	51.30	20.80
24	MC2416-251	240.00	M16	98.00	42.00	42.50	56.60	23.50
25	MC2416-252	240.00	M16	119.50	40.50	37.50	79.80	20.80
26	MC2420	240.00	M20	89.00	42.00	39.50	47.40	21.10
27	MC2420-230	240.00	M20	86.00	39.00	42.00	47.40	22.50
28	MC2420-231	240.00	M20	93.50	39.00	38.00	54.80	21.00
29	MC2420-232	240.00	M20	93.00	39.00	39.00	54.30	21.00
30	MC2420-240	240.00	M20	91.50	40.50	38.00	51.30	21.00

240 mm²

Metric Wire Connector / One hole 0° / 240 mm²

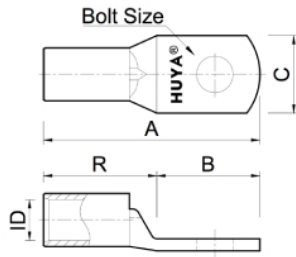

Installation Information

Manufacturer	Tools	Color	Code
T&B	TBM62 BPLT14	--	48
Panduit	CT-2001 CT-930	--	P87
Burndy	PAT600 Y35	--	20
Celestra	A45	--	48

#	Cat.No	Wire Size (mm ²)	Dimension (mm)					
			Bolt Size	A	B	C	R	ID
31	MC2420-250	240.00	M20	91.50	40.50	37.50	51.30	20.80
32	MC2420-251	240.00	M20	98.00	42.00	42.50	56.60	23.50
33	MC2420-252	240.00	M20	119.50	40.50	37.50	79.80	20.80
34	MR2412	240.00	M12	108.00	31.50	42.00	58.30	21.50
35	MR2414	240.00	M14	108.00	34.50	42.00	58.30	21.50
36	MR2416	240.00	M16	111.00	37.50	42.00	58.30	21.50
37	MR2420	240.00	M20	114.00	42.50	45.00	58.30	21.50

300 mm²

Metric Wire Connector / One hole 0°

300 mm²

Metric Wire Connector / One hole 0° / 300 mm²

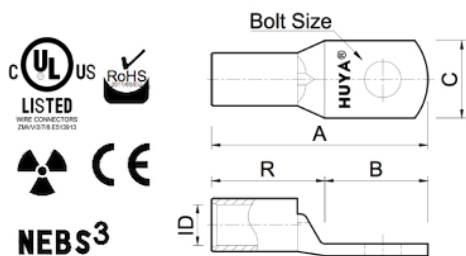

Installation Information

Manufacturer	Tools	Color	Code
T&B	BPLT14	--	60
Panduit	CT-930 CT-940	--	P94
Burndy	PAT750 Y35	--	22
Celestra	A45	--	60

#	Cat.No	Wire Size (mm ²)	Dimension (mm)					
			Bolt Size	A	B	C	R	ID
1	MC3110	300.00	M10	90.00	31.00	44.50	58.10	23.70
2	MC3110-230	300.00	M10	113.00	54.00	45.50	58.10	24.50
3	MC3110-250	300.00	M10	100.80	42.00	42.50	58.10	23.50
4	MC3110-251	300.00	M10	113.50	50.00	48.00	62.60	26.20
5	MC3110-252	300.00	M10	129.00	42.00	42.50	86.20	23.50
6	MC3112	300.00	M12	93.00	34.00	44.50	58.10	23.70
7	MC3112-230	300.00	M12	113.00	54.00	45.50	58.10	24.50
8	MC3112-231	300.00	M12	100.50	39.00	44.00	60.80	24.00
9	MC3112-232	300.00	M12	100.50	39.00	44.00	60.80	24.00
10	MC3112-240	300.00	M12	110.50	48.00	43.00	61.80	23.50
11	MC3112-250	300.00	M12	100.80	42.00	42.50	58.10	23.50
12	MC3112-251	300.00	M12	113.50	50.00	48.00	62.60	26.20
13	MC3112-252	300.00	M12	129.00	42.00	42.50	86.20	23.50
14	MC3114	300.00	M14	97.00	38.00	44.50	58.10	23.70
15	MC3114-240	300.00	M14	110.50	48.00	43.00	61.80	23.50
16	MC3116	300.00	M16	100.00	41.00	44.50	58.10	23.70
17	MC3116-230	300.00	M16	113.00	54.00	45.50	58.10	24.50
18	MC3116-231	300.00	M16	100.50	39.00	44.00	60.80	24.00
19	MC3116-232	300.00	M16	100.50	39.00	44.00	60.80	24.00
20	MC3116-240	300.00	M16	110.50	48.00	43.00	61.80	23.50
21	MC3116-250	300.00	M16	100.80	42.00	42.50	58.10	23.50
22	MC3116-251	300.00	M16	113.50	50.00	48.00	62.60	26.20
23	MC3116-252	300.00	M16	129.00	42.00	42.50	86.20	23.50
24	MC3120	300.00	M20	106.00	47.00	44.50	58.10	23.70
25	MC3120-230	300.00	M20	113.00	54.00	45.50	58.10	24.50
26	MC3120-231	300.00	M20	100.50	39.00	44.00	60.80	24.00
27	MC3120-232	300.00	M20	100.50	39.00	44.00	60.80	24.00
28	MC3120-240	300.00	M20	110.50	48.00	43.00	61.80	23.50
29	MC3120-250	300.00	M20	100.80	42.00	42.50	58.10	23.50
30	MC3120-251	300.00	M20	113.50	50.00	48.00	62.60	26.20

300 mm²

Metric Wire Connector / One hole 0° / 300 mm²

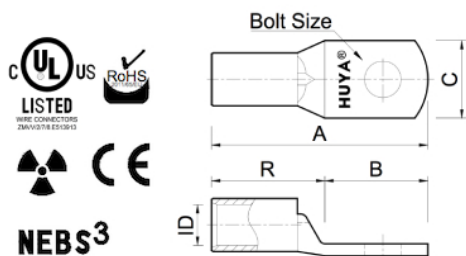

Installation Information

Manufacturer	Tools	Color	Code
T&B	BPLT14	--	60
Panduit	CT-930 CT-940	--	P94
Burndy	PAT750 Y35	--	22
Celestra	A45	--	60

#	Cat.No	Wire Size (mm ²)	Dimension (mm)					
			Bolt Size	A	B	C	R	ID
31	MC3120-252	300.00	M20	129.00	42.00	42.50	86.20	23.50
32	MC3124-230	300.00	M24	113.00	54.00	45.50	58.10	24.50
33	MCX3110-252	300.00	M10	143.00	50.00	48.00	90.80	26.20
34	MCX3112-252	300.00	M12	143.00	50.00	48.00	90.80	26.20
35	MCX3116-252	300.00	M16	143.00	50.00	48.00	90.80	26.20
36	MCX3120-252	300.00	M20	143.00	50.00	48.00	90.80	26.20
37	MR3114	300.00	M14	116.00	36.50	48.00	69.80	24.50
38	MR3116	300.00	M16	119.00	39.50	48.00	69.80	24.50
39	MR3120	300.00	M20	122.00	42.50	48.00	69.80	24.50

400 mm²

Metric Wire Connector / One hole 0°

400 mm²

Metric Wire Connector / One hole 0° / 400 mm²

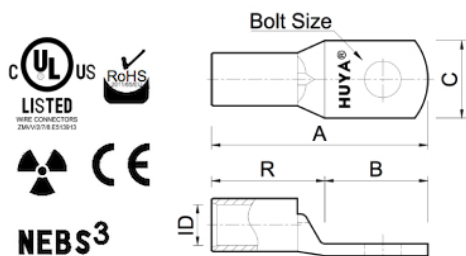

Installation Information

Manufacturer	Tools	Color	Code
T&B	BPLT14 TBM26	--	80
Panduit	CT-930 CT-940	--	P106
Burndy	PAT750 Y35	--	24
Celestra	A45	--	80

#	Cat.No	Wire Size (mm ²)	Dimension (mm)					
			Bolt Size	A	B	C	R	ID
1	MC4110	400.00	M10	102.00	41.00	50.50	61.90	27.00
2	MC4112	400.00	M12	102.00	41.00	50.50	61.90	27.00
3	MC4112-230	400.00	M12	125.00	55.00	55.00	71.30	30.00
4	MC4112-240	400.00	M12	112.00	48.00	49.00	65.30	27.00
5	MC4112-250	400.00	M12	114.80	50.00	49.50	66.10	27.00
6	MC4112-252	400.00	M12	135.50	50.00	49.50	86.50	27.00
7	MC4114	400.00	M14	102.00	41.00	50.50	61.90	27.00
8	MC4114-240	400.00	M14	112.00	48.00	49.00	65.30	27.00
9	MC4116	400.00	M16	102.00	41.00	50.50	61.90	27.00
10	MC4116-230	400.00	M16	125.00	55.00	55.00	71.30	30.00
11	MC4116-231	400.00	M16	114.50	52.00	47.00	63.30	26.00
12	MC4116-232	400.00	M16	116.00	53.00	47.00	64.30	26.00
13	MC4116-240	400.00	M16	112.00	48.00	49.00	65.30	27.00
14	MC4116-250	400.00	M16	114.80	50.00	49.50	66.10	27.00
15	MC4116-252	400.00	M16	135.50	50.00	49.50	86.50	27.00
16	MC4120	400.00	M20	108.00	47.00	50.50	61.90	27.00
17	MC4120-230	400.00	M20	125.00	55.00	55.00	71.30	30.00
18	MC4120-231	400.00	M20	114.50	52.00	47.00	63.30	26.00
19	MC4120-232	400.00	M20	116.00	53.00	47.00	64.30	26.00
20	MC4120-240	400.00	M20	112.00	48.00	49.00	65.30	27.00
21	MC4120-250	400.00	M20	114.80	50.00	49.50	66.10	27.00
22	MC4120-252	400.00	M20	135.50	50.00	49.50	86.50	27.00
23	MC4124-230	400.00	M24	125.00	55.00	55.00	71.30	30.00
24	MC4124-231	400.00	M24	114.50	52.00	47.00	63.30	26.00
25	MC4124-232	400.00	M24	116.00	53.00	47.00	64.30	26.00
26	MR4114	400.00	M14	140.00	48.50	55.00	93.30	27.50
27	MR4116	400.00	M16	140.00	48.50	55.00	93.30	27.50
28	MR4120	400.00	M20	140.00	48.50	55.00	93.30	27.50

500 mm²

Metric Wire Connector / One hole 0°

500 mm²

Metric Wire Connector / One hole 0° / 500 mm²

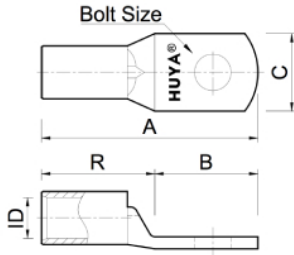

Installation Information

Manufacturer	Tools	Color	Code
T&B	TBM26 TBM60	--	100
Panduit	CT-930 CT-940	--	P125
Burndy	PAT750 Y35	--	L115
Celestra	A45	--	100

#	Cat.No	Wire Size (mm ²)	Dimension (mm)					
			Bolt Size	A	B	C	R	ID
1	MC5110	500.00	M10	97.00	34.00	56.50	65.80	30.30
2	MC5112	500.00	M12	104.00	41.00	56.50	65.80	30.30
3	MC5112-250	500.00	M12	121.50	54.00	57.50	69.80	31.00
4	MC5112-252	500.00	M12	151.00	54.00	57.50	99.50	31.00
5	MC5116	500.00	M16	104.00	41.00	56.50	65.80	30.30
6	MC5116-230	500.00	M16	146.00	60.00	61.00	88.30	33.00
7	MC5116-231	500.00	M16	146.00	60.00	58.00	88.30	31.00
8	MC5116-232	500.00	M16	146.00	60.00	58.00	88.30	31.00
9	MC5116-250	500.00	M16	121.50	54.00	57.50	69.80	31.00
10	MC5116-252	500.00	M16	151.00	54.00	57.50	99.50	31.00
11	MC5120	500.00	M20	110.00	47.00	56.50	65.80	30.30
12	MC5120-230	500.00	M20	146.00	60.00	61.00	88.30	33.00
13	MC5120-231	500.00	M20	146.00	60.00	58.00	88.30	31.00
14	MC5120-232	500.00	M20	146.00	60.00	58.00	88.30	31.00
15	MC5120-250	500.00	M20	121.50	54.00	57.50	69.80	31.00
16	MC5120-252	500.00	M20	151.00	54.00	57.50	99.50	31.00
17	MC5124-230	500.00	M24	146.00	60.00	61.00	88.30	33.00
18	MC5124-231	500.00	M24	146.00	60.00	58.00	88.30	31.00
19	MC5124-232	500.00	M24	146.00	60.00	58.00	88.30	31.00
20	MR5116	500.00	M16	150.00	48.50	60.00	95.30	31.00
21	MR5120	500.00	M20	150.00	48.50	60.00	95.30	31.00

625 mm²

Metric Wire Connector / One hole 0°

625 mm²

Metric Wire Connector / One hole 0° / 625 mm²

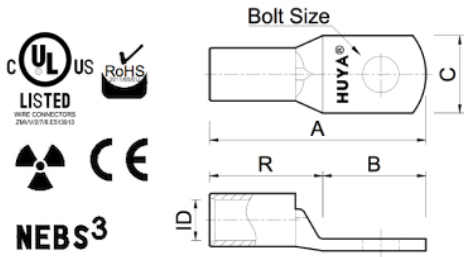

Installation Information

Manufacturer	Tools	Color	Code
T&B	TBM26 TBM60	--	120
Panduit	CT-930 CT-940	--	P125
Burndy	PAT750 Y35	--	29
Celestra	A45	--	120

#	Cat.No	Wire Size (mm ²)	Dimension (mm)					
			Bolt Size	A	B	C	R	ID
1	MR6216	625.00	M16	160.00	48.50	60.00	105.30	34.50
2	MR6220	625.00	M20	160.00	48.50	60.00	105.30	34.50

630 mm²

Metric Wire Connector / One hole 0°

630 mm²

Metric Wire Connector / One hole 0° / 630 mm²

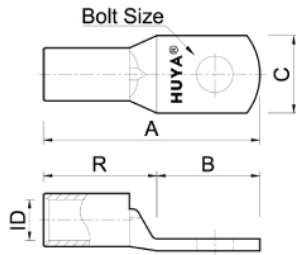
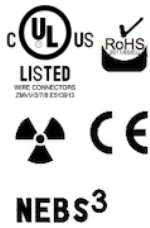

Installation Information

Manufacturer	Tools	Color	Code
T&B	TBM26 TBM60	--	120
Panduit	CT-930 CT-940	--	P125
Burndy	PAT750 Y35	--	29
Celestra	A45	--	120

#	Cat.No	Wire Size (mm ²)	Dimension (mm)					
			Bolt Size	A	B	C	R	ID
1	MC6316	630.00	M16	119.00	41.00	61.60	76.90	33.40
2	MC6316-250	630.00	M16	136.20	56.00	63.50	79.50	34.50
3	MC6316-252	630.00	M16	164.50	56.00	63.50	107.60	34.50
4	MC6320	630.00	M20	125.00	47.00	61.60	76.90	33.40
5	MC6320-231	630.00	M20	149.00	60.00	65.00	88.30	34.00
6	MC6320-232	630.00	M20	149.00	60.00	65.00	88.30	34.00
7	MC6320-250	630.00	M20	136.20	56.00	63.50	79.50	34.50
8	MC6320-252	630.00	M20	164.50	56.00	63.50	107.60	34.50
9	MC6324-231	630.00	M24	149.00	60.00	65.00	88.30	34.00
10	MC6324-232	630.00	M24	149.00	60.00	65.00	88.30	34.00

6 mm²

Metric Wire Connector / One hole 45°

6 mm²

Metric Wire Connector / One hole 45° / 6 mm²

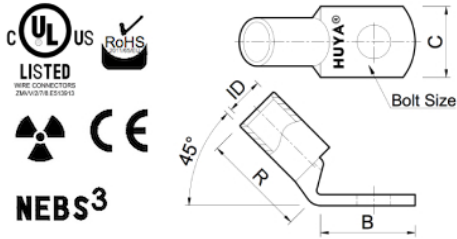

Installation Information

Manufacturer	Tools	Color	Code
T&B	TBM62	--	--
Panduit	CT-100 CT1701	--	P10
Burndy	Y10D Y10R4BY	--	--
Celestra	A45	--	--

#	Cat.No	Wire Size (mm ²)	Dimension (mm)				
			Bolt Size	B	C	R	ID
1	MC0605F-40	6.00	M5	16.50	10.00	13.00	3.50
2	MC0606F-40	6.00	M6	17.50	12.00	13.00	3.50
3	MC0608F-40	6.00	M8	23.00	14.00	13.00	3.50
4	MC0610F-40	6.00	M10	27.00	17.00	13.00	3.50
5	MC0612F-40	6.00	M12	30.00	19.00	13.00	3.50

10 mm²

Metric Wire Connector / One hole 45°

10 mm²

Metric Wire Connector / One hole 45° / 10 mm²

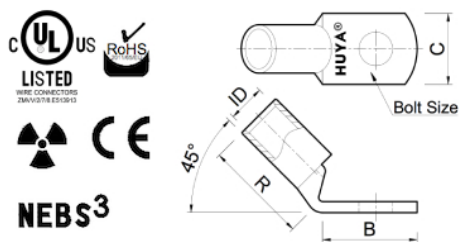

Installation Information

Manufacturer	Tools	Color	Code
T&B	TBM62 BPLT14	--	2
Panduit	CT-2001 CT-930	--	P21
Burndy	PAT600 Y35	--	49
Celestra	A45	--	2

#	Cat.No	Wire Size (mm ²)	Dimension (mm)				
			Bolt Size	B	C	R	ID
1	MC1005F-40	10.00	M5	16.50	12.00	14.80	4.50
2	MC1005F-50	10.00	M5	15.80	10.50	28.80	4.50
3	MC1006F-30	10.00	M6	18.00	12.00	13.80	5.00
4	MC1006F-30NH	10.00	M6	18.00	11.00	14.80	4.50
5	MC1006F-40	10.00	M6	16.50	12.00	14.80	4.50
6	MC1006F-50	10.00	M6	15.80	10.80	28.80	4.50
7	MC1008F-30	10.00	M8	20.50	13.00	13.80	5.00
8	MC1008F-30NH	10.00	M8	20.50	13.00	14.80	4.50
9	MC1008F-40	10.00	M8	23.00	15.00	14.80	4.50
10	MC1008F-50	10.00	M8	16.50	13.00	28.80	4.50
11	MC1010F-40	10.00	M10	27.00	17.00	14.80	4.50
12	MC1010F-50	10.00	M10	16.50	15.00	28.80	4.40
13	MC1012F-40	10.00	M12	31.00	19.00	14.80	4.50

16 mm²

Metric Wire Connector / One hole 45°

16 mm²

Metric Wire Connector / One hole 45° / 16 mm²

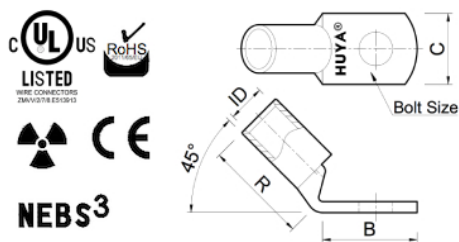

Installation Information

Manufacturer	Tools	Color	Code
T&B	TBM62 BPLT14	--	3
Panduit	CT-2001 CT-930	--	P24
Burndy	PAT600 Y35	--	7
Celestra	A45	--	3

#	Cat.No	Wire Size (mm ²)	Dimension (mm)				
			Bolt Size	B	C	R	ID
1	MC1605F-40	16.00	M5	17.50	12.00	18.10	5.50
2	MC1605F-50	16.00	M5	16.80	11.50	32.30	5.50
3	MC1606F-30	16.00	M6	18.00	13.00	17.10	6.00
4	MC1606F-30NH	16.00	M6	18.00	12.00	20.10	5.40
5	MC1606F-40	16.00	M6	18.50	12.00	18.10	5.50
6	MC1606F-50	16.00	M6	16.80	11.50	32.30	5.50
7	MC1608F-30	16.00	M8	20.50	13.50	17.10	6.00
8	MC1608F-30NH	16.00	M8	20.50	12.00	20.10	5.40
9	MC1608F-40	16.00	M8	23.00	15.00	18.10	5.50
10	MC1608F-50	16.00	M8	16.80	13.00	32.30	5.50
11	MC1610F-30NH	16.00	M10	25.00	16.00	20.10	5.40
12	MC1610F-40	16.00	M10	27.00	17.00	18.10	5.50
13	MC1610F-50	16.00	M10	18.20	15.00	32.30	5.50
14	MC1612F-40	16.00	M12	31.00	19.00	18.10	5.50

25 mm²

Metric Wire Connector / One hole 45°

25 mm²

Metric Wire Connector / One hole 45° / 25 mm²

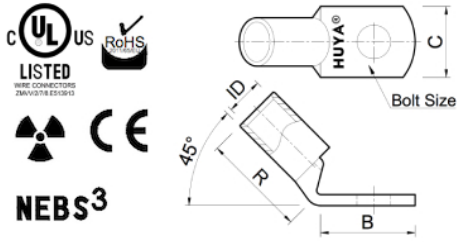

Installation Information

Manufacturer	Tools	Color	Code
T&B	TBM62 BPLT14	--	5
Panduit	CT-2001 CT-930	--	P29
Burndy	PAT600 Y35	--	9
Celestra	A45	--	5

#	Cat.No	Wire Size (mm ²)	Dimension (mm)				
			Bolt Size	B	C	R	ID
1	MC2505F-40	25.00	M5	18.50	14.00	21.50	7.00
2	MC2506F-30	25.00	M6	18.00	17.00	17.50	8.00
3	MC2506F-30NH	25.00	M6	18.00	14.00	23.00	7.00
4	MC2506F-40	25.00	M6	18.50	14.00	21.50	7.00
5	MC2506F-50	25.00	M6	18.00	14.00	33.20	6.90
6	MC2508F-30	25.00	M8	20.50	17.00	17.50	8.00
7	MC2508F-30NH	25.00	M8	20.50	14.00	23.00	7.00
8	MC2508F-40	25.00	M8	23.00	16.00	21.50	7.00
9	MC2508F-50	25.00	M8	18.00	15.50	33.20	6.90
10	MC2510F-30	25.00	M10	25.00	17.00	17.50	8.00
11	MC2510F-30NH	25.00	M10	25.00	15.00	23.00	7.00
12	MC2510F-40	25.00	M10	27.00	18.00	21.50	7.00
13	MC2510F-50	25.00	M10	18.00	15.50	33.20	6.90
14	MC2512F-40	25.00	M12	31.00	19.00	21.50	7.00
15	MC2514F-40	25.00	M14	34.50	21.00	21.50	7.00

35 mm²

Metric Wire Connector / One hole 45°

35 mm²

Metric Wire Connector / One hole 45° / 35 mm²

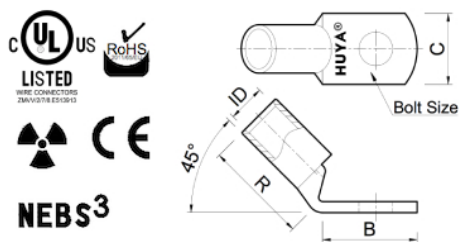

Installation Information

Manufacturer	Tools	Color	Code
T&B	TBM62 BPLT14	--	7
Panduit	CT-2001 CT-930	--	P29
Burndy	PAT600 Y35	--	10
Celestra	A45	--	7

#	Cat.No	Wire Size (mm ²)	Dimension (mm)				
			Bolt Size	B	C	R	ID
1	MC3506F-30	35.00	M6	18.00	18.00	20.50	9.00
2	MC3506F-30NH	35.00	M6	18.00	17.00	28.20	8.50
3	MC3506F-40	35.00	M6	18.50	17.00	23.50	8.50
4	MC3506F-50	35.00	M6	20.80	15.50	39.30	8.20
5	MC3508F-30	35.00	M8	20.50	18.00	20.50	9.00
6	MC3508F-30NH	35.00	M8	20.50	17.00	28.20	8.50
7	MC3508F-40	35.00	M8	23.00	17.00	23.50	8.50
8	MC3508F-50	35.00	M8	20.80	15.50	39.30	8.20
9	MC3510F-30	35.00	M10	25.00	18.00	20.50	9.00
10	MC3510F-30NH	35.00	M10	25.00	18.00	28.20	8.50
11	MC3510F-40	35.00	M10	27.00	19.00	23.50	8.50
12	MC3510F-50	35.00	M10	20.80	15.50	39.30	8.20
13	MC3512F-40	35.00	M12	31.00	21.00	23.50	8.50
14	MC3512F-50	35.00	M12	26.00	21.50	39.30	8.20
15	MC3514F-40	35.00	M14	34.50	21.00	23.50	8.50
16	MC3516F-40	35.00	M16	38.00	26.00	23.50	8.50

50 mm²

Metric Wire Connector / One hole 45°

50 mm²

Metric Wire Connector / One hole 45° / 50 mm²

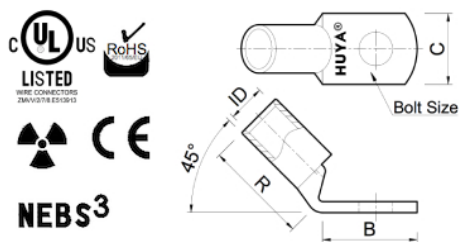

Installation Information

Manufacturer	Tools	Color	Code
T&B	TBM62 BPLT14	--	10
Panduit	CT-2001 CT-930	--	P37
Burndy	PAT600 Y35	--	12
Celestra	A45	--	10

#	Cat.No	Wire Size (mm ²)	Dimension (mm)				
			Bolt Size	B	C	R	ID
1	MC5006F-40	50.00	M6	23.00	20.00	26.20	10.00
2	MC5006F-50	50.00	M6	21.50	18.00	43.80	9.80
3	MC5008F-30	50.00	M8	26.00	21.00	27.90	11.00
4	MC5008F-30NH	50.00	M8	26.00	20.00	30.90	10.00
5	MC5008F-40	50.00	M8	23.00	20.00	26.20	10.00
6	MC5008F-50	50.00	M8	21.50	18.00	43.80	9.80
7	MC5010F-30	50.00	M10	30.00	21.00	27.90	11.00
8	MC5010F-30NH	50.00	M10	30.00	20.00	30.90	10.00
9	MC5010F-40	50.00	M10	28.00	20.00	26.20	10.00
10	MC5010F-50	50.00	M10	21.50	18.00	43.80	9.80
11	MC5012F-30	50.00	M12	32.00	21.00	27.90	11.00
12	MC5012F-30NH	50.00	M12	32.00	21.00	30.90	10.00
13	MC5012F-40	50.00	M12	31.00	23.00	26.20	10.00
14	MC5012F-50	50.00	M12	25.00	23.00	43.80	9.80
15	MC5014F-40	50.00	M14	34.50	23.00	26.20	10.00
16	MC5016F-40	50.00	M16	38.00	28.00	26.20	10.00
17	MC5020F-40	50.00	M20	43.00	30.00	26.20	10.00

70 mm²

Metric Wire Connector / One hole 45°

70 mm²

Metric Wire Connector / One hole 45° / 70 mm²

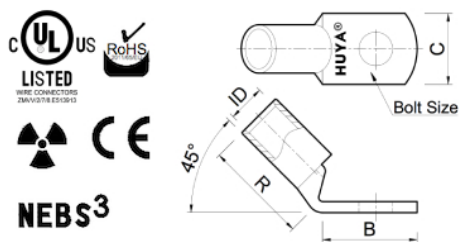

Installation Information

Manufacturer	Tools	Color	Code
T&B	TBM62 BPLT14	--	14
Panduit	CT-2001 CT-930	--	P45
Burndy	PAT600 Y35	--	13
Celestra	A45	--	14

#	Cat.No	Wire Size (mm ²)	Dimension (mm)				
			Bolt Size	B	C	R	ID
1	MC7006F-40	70.00	M6	23.00	23.00	29.10	12.00
2	MC7006F-50	70.00	M6	26.00	20.80	46.10	11.50
3	MC7008F-30	70.00	M8	26.00	25.00	28.10	13.00
4	MC7008F-30NH	70.00	M8	26.00	23.00	32.50	12.00
5	MC7008F-40	70.00	M8	24.00	23.00	29.10	12.00
6	MC7008F-50	70.00	M8	26.00	20.80	46.10	11.50
7	MC7010F-30	70.00	M10	30.00	25.00	28.10	13.00
8	MC7010F-30NH	70.00	M10	30.00	23.00	32.50	12.00
9	MC7010F-40	70.00	M10	28.00	23.00	29.10	12.00
10	MC7010F-50	70.00	M10	26.00	20.80	46.10	11.50
11	MC7012F-30	70.00	M12	32.00	25.00	28.10	13.00
12	MC7012F-30NH	70.00	M12	32.00	23.00	32.50	12.00
13	MC7012F-40	70.00	M12	31.00	23.00	29.10	12.00
14	MC7012F-50	70.00	M12	26.00	20.80	46.10	11.50
15	MC7014F-40	70.00	M14	34.50	23.00	29.10	12.00
16	MC7016F-40	70.00	M16	38.00	28.00	29.10	12.00
17	MC7020F-40	70.00	M20	43.00	30.00	29.10	12.00

95 mm²

Metric Wire Connector / One hole 45°

95 mm²

Metric Wire Connector / One hole 45° / 95 mm²

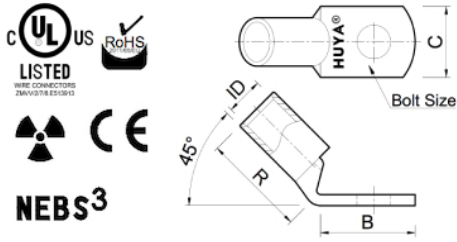

Installation Information

Manufacturer	Tools	Color	Code
T&B	TBM62 BPLT14	--	19
Panduit	CT-2001 CT-930	--	P54
Burndy	MY29 Y644M	--	14
Celestra	A45	--	19

#	Cat.No	Wire Size (mm ²)	Dimension (mm)				
			Bolt Size	B	C	R	ID
1	MC9508F-30NH	95.00	M8	26.00	26.00	36.60	13.50
2	MC9508F-40	95.00	M8	26.00	26.00	33.10	13.50
3	MC9508F-50	95.00	M8	28.50	24.50	51.10	13.50
4	MC9510F-30	95.00	M10	30.00	29.00	31.10	15.00
5	MC9510F-30NH	95.00	M10	30.00	26.00	36.60	13.50
6	MC9510F-40	95.00	M10	29.00	26.00	33.10	13.50
7	MC9510F-50	95.00	M10	28.50	24.50	51.10	13.50
8	MC9512F-30	95.00	M12	32.00	29.00	31.10	15.00
9	MC9512F-30NH	95.00	M12	32.00	26.00	36.60	13.50
10	MC9512F-40	95.00	M12	31.00	26.00	33.10	13.50
11	MC9512F-50	95.00	M12	28.50	24.50	51.10	13.50
12	MC9514F-40	95.00	M14	34.50	26.00	33.10	13.50
13	MC9516F-30	95.00	M16	36.00	29.00	31.10	15.00
14	MC9516F-30NH	95.00	M16	36.00	27.00	36.60	13.50
15	MC9516F-40	95.00	M16	38.00	28.00	33.10	13.50
16	MC9516F-50	95.00	M16	28.50	24.50	51.10	13.50
17	MC9520F-40	95.00	M20	46.00	36.00	33.10	13.50

120 mm²

Metric Wire Connector / One hole 45°

120 mm²

Metric Wire Connector / One hole 45° / 120 mm²

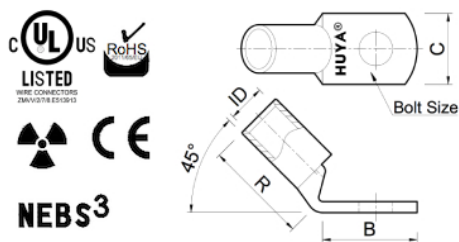

Installation Information

Manufacturer	Tools	Color	Code
T&B	TBM62 BPLT14	--	24
Panduit	CT-2001 CT-930	--	P62
Burndy	PAT600 Y35	--	15
Celestra	A45	--	24

#	Cat.No	Wire Size (mm ²)	Dimension (mm)				
			Bolt Size	B	C	R	ID
1	MC1208F-40	120.00	M8	30.00	28.00	34.90	15.00
2	MC1208F-50	120.00	M8	30.00	27.50	48.60	15.20
3	MC1210F-30	120.00	M10	30.00	32.00	33.90	17.00
4	MC1210F-30NH	120.00	M10	30.00	28.00	38.90	15.00
5	MC1210F-40	120.00	M10	31.00	28.00	34.90	15.00
6	MC1210F-50	120.00	M10	30.00	27.50	48.60	15.20
7	MC1212F-30	120.00	M12	32.00	32.00	33.90	17.00
8	MC1212F-30NH	120.00	M12	32.00	28.00	38.90	15.00
9	MC1212F-40	120.00	M12	32.00	28.00	34.90	15.00
10	MC1212F-50	120.00	M12	30.00	27.50	48.60	15.20
11	MC1214F-40	120.00	M14	35.00	28.00	34.90	15.00
12	MC1216F-30	120.00	M16	36.00	32.00	33.90	17.00
13	MC1216F-30NH	120.00	M16	36.00	28.00	38.90	15.00
14	MC1216F-40	120.00	M16	38.00	30.00	34.90	15.00
15	MC1216F-50	120.00	M16	30.00	27.50	48.60	15.20
16	MC1220F-40	120.00	M20	46.00	36.00	34.90	15.00

150 mm²

Metric Wire Connector / One hole 45°

150 mm²

Metric Wire Connector / One hole 45° / 150 mm²

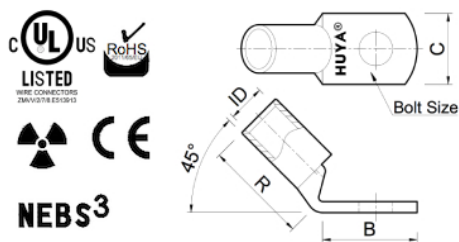

Installation Information

Manufacturer	Tools	Color	Code
T&B	TBM62 BPLT14	--	30
Panduit	CT-2001 CT-930	--	P66
Burndy	PAT600 Y35	--	17
Celestra	A45	--	30

#	Cat.No	Wire Size (mm ²)	Dimension (mm)				
			Bolt Size	B	C	R	ID
1	MC1508F-40	150.00	M8	30.00	31.00	40.20	16.50
2	MC1508F-50	150.00	M8	34.50	30.50	67.20	16.50
3	MC1510F-30	150.00	M10	30.00	36.00	40.20	19.00
4	MC1510F-40	150.00	M10	31.00	31.00	40.20	16.50
5	MC1510F-50	150.00	M10	34.50	30.50	67.20	16.50
6	MC1512F-30	150.00	M12	32.00	36.00	40.20	19.00
7	MC1512F-40	150.00	M12	33.00	31.00	40.20	16.50
8	MC1512F-50	150.00	M12	34.50	30.50	67.20	16.50
9	MC1514F-40	150.00	M14	35.00	31.00	40.20	16.50
10	MC1516F-30	150.00	M16	36.00	36.00	40.20	19.00
11	MC1516F-40	150.00	M16	38.00	31.00	40.20	16.50
12	MC1516F-50	150.00	M16	34.50	30.50	67.20	16.50
13	MC1520F-40	150.00	M20	46.00	36.00	40.20	16.50
14	MC1520F-50	150.00	M20	38.50	30.50	67.20	16.50

185 mm²

Metric Wire Connector / One hole 45°

185 mm²

Metric Wire Connector / One hole 45° / 185 mm²

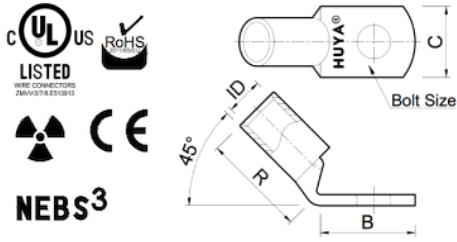

Installation Information

Manufacturer	Tools	Color	Code
T&B	TBM62 BPLT14	--	37
Panduit	CT-2001 CT-930	--	P76
Burndy	PAT600 Y35	--	18
Celestra	A45	--	37

#	Cat.No	Wire Size (mm ²)	Dimension (mm)				
			Bolt Size	B	C	R	ID
1	MC1810F-40	185.00	M10	40.00	35.00	42.70	19.00
2	MC1810F-50	185.00	M10	35.50	33.50	69.00	18.60
3	MC1812F-40	185.00	M12	40.00	35.00	42.70	19.00
4	MC1812F-50	185.00	M12	35.50	33.50	69.00	18.60
5	MC1814F-40	185.00	M14	40.00	35.00	42.70	19.00
6	MC1816F-40	185.00	M16	40.00	35.00	42.70	19.00
7	MC1816F-50	185.00	M16	35.50	33.50	69.00	18.60
8	MC1820F-40	185.00	M20	46.00	39.00	42.70	19.00
9	MC1820F-50	185.00	M20	38.50	33.50	69.00	18.60

240 mm²

Metric Wire Connector / One hole 45°

240 mm²

Metric Wire Connector / One hole 45° / 240 mm²

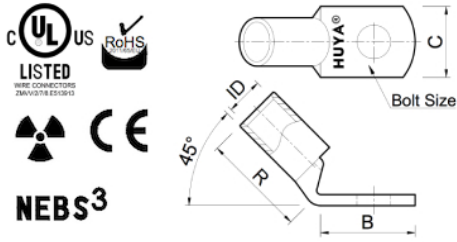

Installation Information

Manufacturer	Tools	Color	Code
T&B	TBM62 BPLT14	--	48
Panduit	CT-2001 CT-930	--	P87
Burndy	PAT600 Y35	--	20
Celestra	A45	--	48

#	Cat.No	Wire Size (mm ²)	Dimension (mm)				
			Bolt Size	B	C	R	ID
1	MC2410F-40	240.00	M10	43.50	39.00	51.30	21.00
2	MC2410F-50	240.00	M10	40.50	37.50	79.80	20.80
3	MC2412F-40	240.00	M12	43.50	39.00	51.30	21.00
4	MC2412F-50	240.00	M12	40.50	37.50	79.80	20.80
5	MC2414F-40	240.00	M14	43.50	39.00	51.30	21.00
6	MC2416F-40	240.00	M16	43.50	39.00	51.30	21.00
7	MC2416F-50	240.00	M16	40.50	37.50	79.80	20.80
8	MC2420F-40	240.00	M20	45.50	39.00	51.30	21.00
9	MC2420F-50	240.00	M20	40.50	37.50	79.80	20.80

300 mm²

Metric Wire Connector / One hole 45°

300 mm²

Metric Wire Connector / One hole 45° / 300 mm²

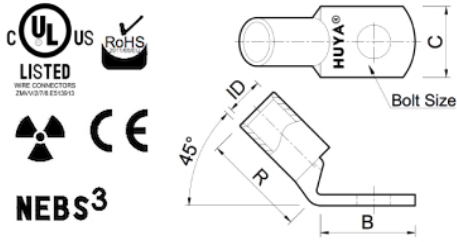

Installation Information

Manufacturer	Tools	Color	Code
T&B	BPLT14	--	60
Panduit	CT-930 CT-940	--	P94
Burndy	PAT750 Y35	--	22
Celestra	A45	--	60

#	Cat.No	Wire Size (mm ²)	Dimension (mm)				
			Bolt Size	B	C	R	ID
1	MC3110F-50	300.00	M10	42.00	42.50	86.20	23.50
2	MC3112F-40	300.00	M12	48.00	43.00	61.80	23.50
3	MC3112F-50	300.00	M12	42.00	42.50	86.20	23.50
4	MC3114F-40	300.00	M14	48.00	43.00	61.80	23.50
5	MC3116F-40	300.00	M16	48.00	43.00	61.80	23.50
6	MC3116F-50	300.00	M16	42.00	42.50	86.20	23.50
7	MC3120F-40	300.00	M20	48.00	43.00	61.80	23.50
8	MC3120F-50	300.00	M20	42.00	42.50	86.20	23.50

400 mm²

Metric Wire Connector / One hole 45°

400 mm²

Metric Wire Connector / One hole 45° / 400 mm²

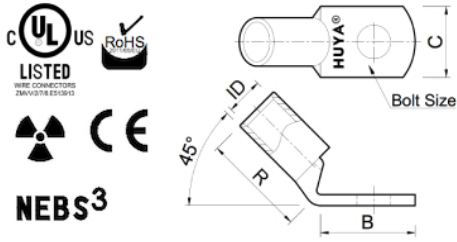

Installation Information

Manufacturer	Tools	Color	Code
T&B	BPLT14 TBM26	--	80
Panduit	CT-930 CT-940	--	P106
Burndy	PAT750 Y35	--	24
Celestra	A45	--	80

#	Cat.No	Wire Size (mm ²)	Dimension (mm)				
			Bolt Size	B	C	R	ID
1	MC4110F-50	400.00	M10	50.00	48.00	94.30	26.20
2	MC4112F-40	400.00	M12	48.00	49.00	65.30	27.00
3	MC4112F-50	400.00	M12	50.00	48.00	94.30	26.20
4	MC4114F-40	400.00	M14	48.00	49.00	65.30	27.00
5	MC4116F-40	400.00	M16	48.00	49.00	65.30	27.00
6	MC4116F-50	400.00	M16	50.00	48.00	94.30	26.20
7	MC4120F-40	400.00	M20	48.00	49.00	65.30	27.00
8	MC4120F-50	400.00	M20	50.00	48.00	94.30	26.20

6 mm²

Metric Wire Connector / One hole 90°

6 mm²

Metric Wire Connector / One hole 90° / 6 mm²

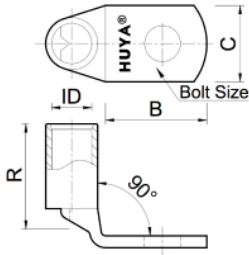

Installation Information

Manufacturer	Tools	Color	Code
T&B	TBM62	--	--
Panduit	CT-100 CT1701	--	P10
Burndy	Y10D Y10R4BY	--	--
Celestra	A45	--	--

#	Cat.No	Wire Size (mm ²)	Dimension (mm)				
			Bolt Size	B	C	R	ID
1	MC0605A-40	6.00	M5	16.50	10.00	13.00	3.50
2	MC0606A-40	6.00	M6	17.50	12.00	13.00	3.50
3	MC0608A-40	6.00	M8	23.00	14.00	13.00	3.50
4	MC0610A-40	6.00	M10	27.00	17.00	13.00	3.50
5	MC0612A-40	6.00	M12	30.00	19.00	13.00	3.50

10 mm²

Metric Wire Connector / One hole 90°

10 mm²

Metric Wire Connector / One hole 90° / 10 mm²

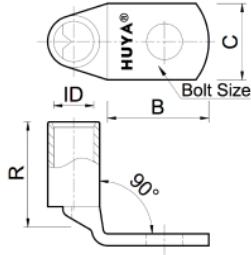

Installation Information

Manufacturer	Tools	Color	Code
T&B	TBM62 BPLT14	--	2
Panduit	CT-100 CT1701	--	P21
Burndy	PAT600 Y35	--	49
Celestra	A45	--	2

#	Cat.No	Wire Size (mm ²)	Dimension (mm)				
			Bolt Size	B	C	R	ID
1	MC1005A-40	10.00	M5	16.50	12.00	14.80	4.50
2	MC1005A-50	10.00	M5	15.80	11.00	28.80	4.50
3	MC1006A-30	10.00	M6	19.50	13.00	19.80	5.00
4	MC1006A-40	10.00	M6	16.50	12.00	14.80	4.50
5	MC1006A-50	10.00	M6	15.80	11.00	28.80	4.50
6	MC1008A-30	10.00	M8	22.00	13.50	19.80	5.00
7	MC1008A-40	10.00	M8	23.00	15.00	14.80	4.50
8	MC1008A-50	10.00	M8	16.50	13.00	28.80	4.50
9	MC1010A-40	10.00	M10	27.00	17.00	14.80	4.50
10	MC1010A-50	10.00	M10	16.50	15.00	28.80	4.40
11	MC1012A-40	10.00	M12	31.00	19.00	14.80	4.50

16 mm²

Metric Wire Connector / One hole 90°

16 mm²

Metric Wire Connector / One hole 90° / 16 mm²

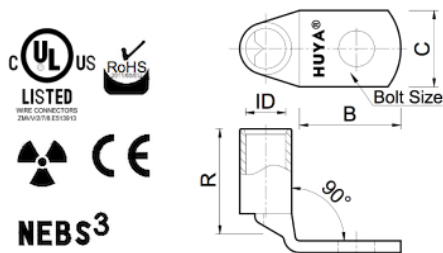

Installation Information

Manufacturer	Tools	Color	Code
T&B	TBM62 BPLT14	--	3
Panduit	CT-2001 CT-930	--	P24
Burndy	PAT600 Y35	--	7
Celestra	A45	--	3

#	Cat.No	Wire Size (mm ²)	Dimension (mm)				
			Bolt Size	B	C	R	ID
1	MC1605A-40	16.00	M5	17.50	12.00	18.10	5.50
2	MC1605A-50	16.00	M5	16.80	13.00	32.30	5.50
3	MC1606A-30	16.00	M6	19.50	13.00	22.10	6.00
4	MC1606A-40	16.00	M6	18.50	12.00	18.10	5.50
5	MC1606A-50	16.00	M6	16.80	13.00	32.30	5.50
6	MC1608A-30	16.00	M8	22.00	13.50	22.10	6.00
7	MC1608A-40	16.00	M8	23.00	15.00	18.10	5.50
8	MC1608A-50	16.00	M8	16.80	13.00	32.30	5.50
9	MC1610A-40	16.00	M10	27.00	17.00	18.10	5.50
10	MC1610A-50	16.00	M10	18.20	15.00	32.30	5.50
11	MC1612A-40	16.00	M12	31.00	19.00	18.10	5.50

25 mm²

Metric Wire Connector / One hole 90°

25 mm²

Metric Wire Connector / One hole 90° / 25 mm²

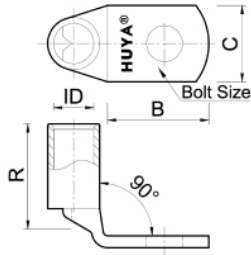

Installation Information

Manufacturer	Tools	Color	Code
T&B	TBM62 BPLT14	--	5
Panduit	CT-2001 CT-930	--	P29
Burndy	PAT600 Y35	--	9
Celestra	A45	--	5

#	Cat.No	Wire Size (mm ²)	Dimension (mm)				
			Bolt Size	B	C	R	ID
1	MC2505A-40	25.00	M5	18.50	14.00	21.50	7.00
2	MC2506A-30	25.00	M6	23.50	17.00	25.00	8.00
3	MC2506A-40	25.00	M6	18.50	14.00	21.50	7.00
4	MC2506A-50	25.00	M6	18.00	14.00	33.20	6.90
5	MC250845-250	25.00	M8	62.50	15.50	25.00	6.90
6	MC2508A-30	25.00	M8	25.50	17.00	21.50	8.00
7	MC2508A-40	25.00	M8	23.00	16.00	33.20	7.00
8	MC2508A-50	25.00	M8	18.00	15.50	25.00	6.90
9	MC2510A-30	25.00	M10	28.50	17.00	21.50	8.00
10	MC2510A-40	25.00	M10	27.00	18.00	33.20	7.00
11	MC2510A-50	25.00	M10	18.00	15.50	21.50	6.90
12	MC2512A-40	25.00	M12	31.00	19.00	21.50	7.00
13	MC2514A-40	25.00	M14	34.50	21.00	21.50	7.00

35 mm²

Metric Wire Connector / One hole 90°

35 mm²

Metric Wire Connector / One hole 90° / 35 mm²

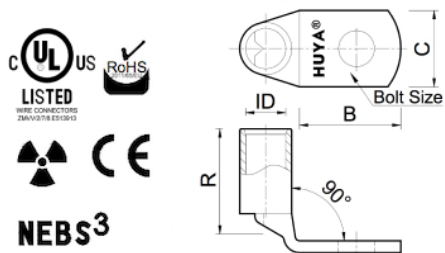

Installation Information

Manufacturer	Tools	Color	Code
T&B	TBM62 BPLT14	--	7
Panduit	CT-2001 CT-930	--	P29
Burndy	PAT600 Y35	--	10
Celestra	A45	--	7

#	Cat.No	Wire Size (mm ²)	Dimension (mm)				
			Bolt Size	B	C	R	ID
1	MC3506A-30	35.00	M6	24.50	18.00	29.00	9.00
2	MC3506A-40	35.00	M6	18.50	17.00	23.50	8.50
3	MC3506A-50	35.00	M6	20.80	15.50	39.30	8.20
4	MC3508A-30	35.00	M8	26.50	18.00	29.00	9.00
5	MC3508A-40	35.00	M8	23.00	17.00	23.50	8.50
6	MC3508A-50	35.00	M8	20.80	15.50	39.30	8.20
7	MC3510A-30	35.00	M10	29.50	18.00	29.00	9.00
8	MC3510A-40	35.00	M10	27.00	19.00	23.50	8.50
9	MC3510A-50	35.00	M10	20.80	15.50	39.30	8.20
10	MC3512A-40	35.00	M12	31.00	21.00	23.50	8.50
11	MC3512A-50	35.00	M12	26.00	21.50	39.30	8.20
12	MC3514A-40	35.00	M14	34.50	21.00	23.50	8.50
13	MC3516A-40	35.00	M16	38.00	26.00	23.50	8.50

50 mm²

Metric Wire Connector / One hole 90°

50 mm²

Metric Wire Connector / One hole 90° / 50 mm²

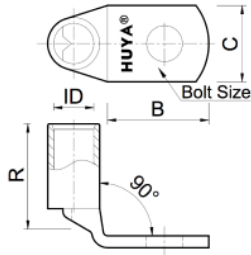

Installation Information

Manufacturer	Tools	Color	Code
T&B	TBM62 BPLT14	--	10
Panduit	CT-2001 CT-930	--	P37
Burndy	PAT600 Y35	--	12
Celestra	A45	--	10

#	Cat.No	Wire Size (mm ²)	Dimension (mm)				
			Bolt Size	B	C	R	ID
1	MC5006A-40	50.00	M6	23.00	20.00	26.20	10.00
2	MC5006A-50	50.00	M6	21.50	18.00	43.80	9.80
3	MC5008A-30	50.00	M8	29.50	21.00	37.70	11.00
4	MC5008A-40	50.00	M8	23.00	20.00	26.20	10.00
5	MC5008A-50	50.00	M8	21.50	18.00	43.80	9.80
6	MC5010A-30	50.00	M10	32.50	21.00	37.70	11.00
7	MC5010A-40	50.00	M10	28.00	20.00	26.20	10.00
8	MC5010A-50	50.00	M10	21.50	18.00	43.80	9.80
9	MC5012A-30	50.00	M12	33.50	21.00	43.80	11.00
10	MC5012A-40	50.00	M12	31.00	23.00	37.70	10.00
11	MC5012A-50	50.00	M12	25.00	23.00	26.20	9.80
12	MC5014A-40	50.00	M14	34.50	23.00	26.20	10.00
13	MC5016A-40	50.00	M16	38.00	28.00	26.20	10.00
14	MC5020A-40	50.00	M20	43.00	30.00	26.20	10.00

70 mm²

Metric Wire Connector / One hole 90°

70 mm²

Metric Wire Connector / One hole 90° / 70 mm²

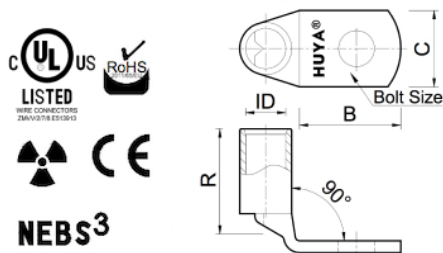

Installation Information

Manufacturer	Tools	Color	Code
T&B	TBM62 BPLT14	--	14
Panduit	CT-2001 CT-930	--	P45
Burndy	PAT600 Y35	--	13
Celestra	A45	--	14

#	Cat.No	Wire Size (mm ²)	Dimension (mm)				
			Bolt Size	B	C	R	ID
1	MC7006A-40	70.00	M6	23.00	23.00	29.10	12.00
2	MC7006A-50	70.00	M6	26.00	20.80	46.10	11.50
3	MC7008A-30	70.00	M8	33.50	25.00	39.60	13.00
4	MC7008A-40	70.00	M8	24.00	23.00	29.10	12.00
5	MC7008A-50	70.00	M8	26.00	20.80	46.10	11.50
6	MC7010A-30	70.00	M10	36.50	25.00	39.60	13.00
7	MC7010A-40	70.00	M10	28.00	23.00	29.10	12.00
8	MC7010A-50	70.00	M10	26.00	20.80	46.10	11.50
9	MC7012A-30	70.00	M12	37.50	25.00	39.60	13.00
10	MC7012A-40	70.00	M12	31.00	23.00	29.10	12.00
11	MC7012A-50	70.00	M12	26.00	20.80	46.10	11.50
12	MC7014A-40	70.00	M14	34.50	23.00	29.10	12.00
13	MC7016A-40	70.00	M16	38.00	28.00	29.10	12.00
14	MC7020A-40	70.00	M20	43.00	30.00	29.10	12.00

95 mm²

Metric Wire Connector / One hole 90°

95 mm²

Metric Wire Connector / One hole 90° / 95 mm²

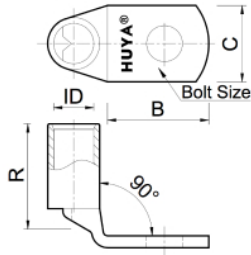

Installation Information

Manufacturer	Tools	Color	Code
T&B	TBM62 BPLT14	--	19
Panduit	CT-2001 CT-930	--	P54
Burndy	MY29 Y644M	--	14
Celestra	A45	--	19

#	Cat.No	Wire Size (mm ²)	Dimension (mm)				
			Bolt Size	B	C	R	ID
1	MC9508A-40	95.00	M8	26.00	26.00	33.10	13.50
2	MC9508A-50	95.00	M8	28.50	24.50	51.10	13.50
3	MC9510A-30	95.00	M10	40.50	29.00	40.60	15.00
4	MC9510A-40	95.00	M10	29.00	26.00	33.10	13.50
5	MC9510A-50	95.00	M10	28.50	24.50	51.10	13.50
6	MC9512A-30	95.00	M12	41.50	29.00	40.60	15.00
7	MC9512A-40	95.00	M12	31.00	26.00	33.10	13.50
8	MC9512A-50	95.00	M12	28.50	24.50	51.10	13.50
9	MC9514A-40	95.00	M14	34.50	26.00	33.10	13.50
10	MC9516A-30	95.00	M16	44.50	29.00	40.60	15.00
11	MC9516A-40	95.00	M16	38.00	28.00	33.10	13.50
12	MC9516A-50	95.00	M16	28.50	24.50	51.10	13.50
13	MC9520A-40	95.00	M20	46.00	36.00	33.10	13.50

120 mm²

Metric Wire Connector / One hole 90°

120 mm²

Metric Wire Connector / One hole 90° / 120 mm²

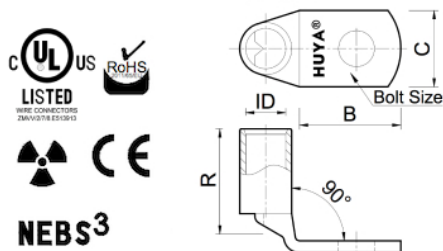

Installation Information

Manufacturer	Tools	Color	Code
T&B	TBM62 BPLT14	--	24
Panduit	CT-2001 CT-930	--	P62
Burndy	PAT600 Y35	--	15
Celestra	A45	--	24

#	Cat.No	Wire Size (mm ²)	Dimension (mm)				
			Bolt Size	B	C	R	ID
1	MC1208A-40	120.00	M8	30.00	28.00	34.90	15.00
2	MC1208A-50	120.00	M8	30.00	27.50	48.60	15.20
3	MC1210A-30	120.00	M10	43.50	32.00	43.40	17.00
4	MC1210A-40	120.00	M10	31.00	28.00	34.90	15.00
5	MC1210A-50	120.00	M10	30.00	27.50	48.60	15.20
6	MC1212A-30	120.00	M12	44.50	32.00	43.40	17.00
7	MC1212A-40	120.00	M12	32.00	28.00	34.90	15.00
8	MC1212A-50	120.00	M12	30.00	27.50	48.60	15.20
9	MC1214A-40	120.00	M14	35.00	28.00	34.90	15.00
10	MC1216A-30	120.00	M16	47.50	32.00	43.40	17.00
11	MC1216A-40	120.00	M16	38.00	30.00	34.90	15.00
12	MC1216A-50	120.00	M16	30.00	27.50	48.60	15.20
13	MC1220A-40	120.00	M20	46.00	36.00	34.90	15.00

150 mm²

Metric Wire Connector / One hole 90°

150 mm²

Metric Wire Connector / One hole 90° / 150 mm²

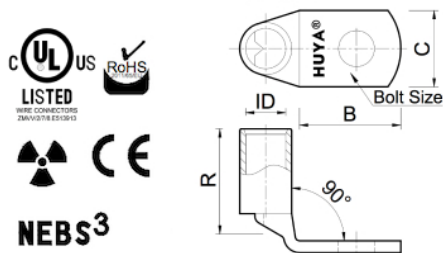

Installation Information

Manufacturer	Tools	Color	Code
T&B	TBM62 BPLT14	--	30
Panduit	CT-2001 CT-930	--	P66
Burndy	PAT600 Y35	--	17
Celestra	A45	--	30

#	Cat.No	Wire Size (mm ²)	Dimension (mm)				
			Bolt Size	B	C	R	ID
1	MC1508A-40	150.00	M8	30.00	31.00	40.20	16.50
2	MC1508A-50	150.00	M8	34.50	30.50	67.20	16.50
3	MC1510A-30	150.00	M10	47.50	36.00	47.70	19.00
4	MC1510A-40	150.00	M10	31.00	31.00	40.20	16.50
5	MC1510A-50	150.00	M10	34.50	30.50	67.20	16.50
6	MC1512A-30	150.00	M12	48.50	36.00	47.70	19.00
7	MC1512A-40	150.00	M12	33.00	31.00	40.20	16.50
8	MC1512A-50	150.00	M12	34.50	30.50	67.20	16.50
9	MC1514A-40	150.00	M14	35.00	31.00	40.20	16.50
10	MC1516A-30	150.00	M16	51.50	36.00	47.70	19.00
11	MC1516A-40	150.00	M16	38.00	31.00	40.20	16.50
12	MC1516A-50	150.00	M16	34.50	30.50	67.20	16.50
13	MC1520A-40	150.00	M20	46.00	36.00	40.20	16.50
14	MC1520A-50	150.00	M20	38.50	30.50	67.20	16.50

185 mm²

Metric Wire Connector / One hole 90°

185 mm²

Metric Wire Connector / One hole 90° / 185 mm²

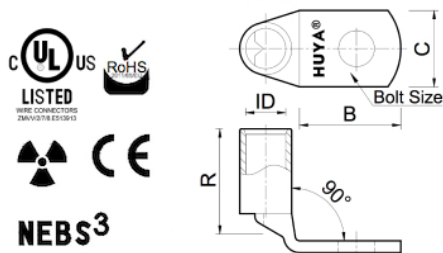

Installation Information

Manufacturer	Tools	Color	Code
T&B	TBM62 BPLT14	--	37
Panduit	CT-2001 CT-930	--	P76
Burndy	PAT600 Y35	--	18
Celestra	A45	--	37

#	Cat.No	Wire Size (mm ²)	Dimension (mm)				
			Bolt Size	B	C	R	ID
1	MC1810A-40	185.00	M10	40.00	35.00	42.70	19.00
2	MC1810A-50	185.00	M10	35.50	33.50	69.00	18.60
3	MC1812A-40	185.00	M12	40.00	35.00	42.70	19.00
4	MC1812A-50	185.00	M12	35.50	33.50	69.00	18.60
5	MC1814A-40	185.00	M14	40.00	35.00	42.70	19.00
6	MC1816A-40	185.00	M16	40.00	35.00	42.70	19.00
7	MC1816A-50	185.00	M16	36.00	33.50	69.00	18.60
8	MC1820A-40	185.00	M20	46.00	39.00	42.70	19.00
9	MC1820A-50	185.00	M20	38.50	33.50	69.00	18.60

240 mm²

Metric Wire Connector / One hole 90°

240 mm²

Metric Wire Connector / One hole 90° / 240 mm²

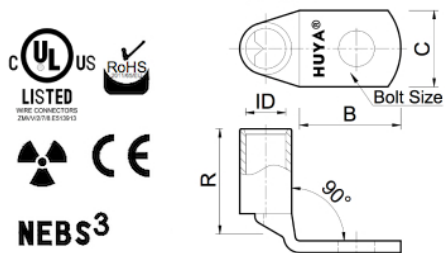

Installation Information

Manufacturer	Tools	Color	Code
T&B	TBM62 BPLT14	--	48
Panduit	CT-2001 CT-930	--	P87
Burndy	PAT600 Y35	--	20
Celestra	A45	--	48

#	Cat.No	Wire Size (mm ²)	Dimension (mm)				
			Bolt Size	B	C	R	ID
1	MC2410A-40	240.00	M10	43.50	39.00	51.30	21.00
2	MC2410A-50	240.00	M10	40.50	37.50	79.80	20.80
3	MC2412A-40	240.00	M12	43.50	39.00	51.30	21.00
4	MC2412A-50	240.00	M12	40.50	37.50	79.80	20.80
5	MC2414A-40	240.00	M14	43.50	39.00	51.30	21.00
6	MC2416A-40	240.00	M16	43.50	39.00	51.30	21.00
7	MC2416A-50	240.00	M16	40.50	37.50	79.80	20.80
8	MC2420A-40	240.00	M20	45.50	39.00	51.30	21.00
9	MC2420A-50	240.00	M20	40.50	37.50	79.80	20.80

300 mm²

Metric Wire Connector / One hole 90°

300 mm²

Metric Wire Connector / One hole 90° / 300 mm²

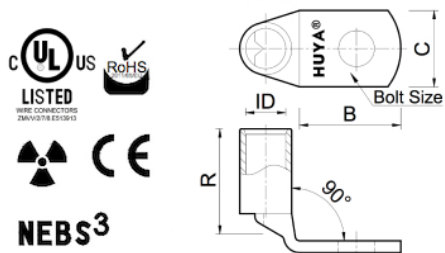

Installation Information

Manufacturer	Tools	Color	Code
T&B	BPLT14	--	60
Panduit	CT-930 CT-940	--	P94
Burndy	PAT750 Y35	--	22
Celestra	A45	--	60

#	Cat.No	Wire Size (mm ²)	Dimension (mm)				
			Bolt Size	B	C	R	ID
1	MC3110A-50	300.00	M10	42.00	42.50	86.20	23.50
2	MC3112A-40	300.00	M12	48.00	43.00	61.80	23.50
3	MC3112A-50	300.00	M12	42.00	42.50	86.20	23.50
4	MC3114A-40	300.00	M14	48.00	43.00	61.80	23.50
5	MC3116A-40	300.00	M16	48.00	43.00	61.80	23.50
6	MC3116A-50	300.00	M16	42.00	42.50	86.20	23.50
7	MC3120A-40	300.00	M20	48.00	43.00	61.80	23.50
8	MC3120A-50	300.00	M20	42.00	42.50	86.20	23.50

400 mm²

Metric Wire Connector / One hole 90°

400 mm²

Metric Wire Connector / One hole 90° / 400 mm²

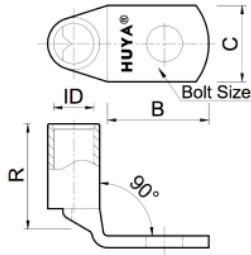

Installation Information

Manufacturer	Tools	Color	Code
T&B	BPLT14 TBM26	--	80
Panduit	CT-930 CT-940	--	P106
Burndy	PAT750 Y35	--	24
Celestra	A45	--	80

#	Cat.No	Wire Size (mm ²)	Dimension (mm)				
			Bolt Size	B	C	R	ID
1	MC4110A-50	400.00	M10	50.00	48.00	94.30	26.20
2	MC4112A-40	400.00	M12	48.00	49.00	65.30	27.00
3	MC4112A-50	400.00	M12	50.00	48.00	94.30	26.20
4	MC4114A-40	400.00	M14	48.00	49.00	65.30	27.00
5	MC4116A-40	400.00	M16	48.00	49.00	65.30	27.00
6	MC4116A-50	400.00	M16	50.00	48.00	94.30	26.20
7	MC4120A-40	400.00	M20	48.00	49.00	65.30	27.00
8	MC4120A-50	400.00	M20	50.00	48.00	94.30	26.20

6 mm²

Metric Wire Connector / Two hole 0°

6 mm²

Metric Wire Connector / Two hole 0° / 6 mm²

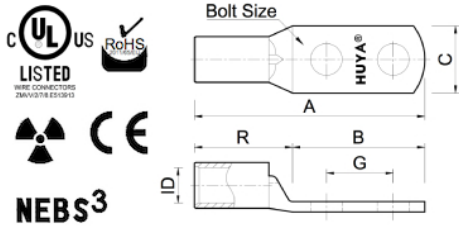

Installation Information

Manufacturer	Tools	Color	Code
T&B	TBM62	--	--
Panduit	CT-100 CT1701	--	P10
Burndy	Y10D Y10R4BY	--	--
Celestra	A45	--	--

#	Cat.No	Wire Size (mm ²)	Dimension (mm)						
			Bolt Size	A	B	C	G	R	ID
1	MC060525-250	6.00	M5	53.00	39.00	10.00	22.0 – 25.0	9.50	3.80
2	MC060525-251	6.00	M5	53.00	39.00	10.00	22.0-25.0	9.50	3.80

10 mm²

Metric Wire Connector / Two hole 0°

10 mm²

Metric Wire Connector / Two hole 0° / 10 mm²

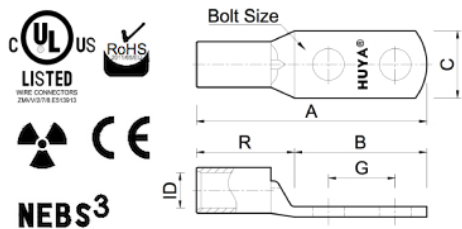

Installation Information

Manufacturer	Tools	Color	Code
T&B	TBM62 BPLT14	--	2
Panduit	CT-2001 CT-930	--	P21
Burndy	PAT600 Y35	--	49
Celestra	A45	--	2

#	Cat.No	Wire Size (mm ²)	Dimension (mm)						
			Bolt Size	A	B	C	G	R	ID
1	MC100625-250	10.00	M6	57.00	40.80	11.00	22.0 – 25.0	11.00	4.50
2	MC100625-251	10.00	M6	58.50	41.80	13.00	22.0 – 25.0	11.50	5.50
3	MC100845-250	10.00	M8	77.50	61.00	13.00	44.50	11.50	4.50
4	MC100845-251	10.00	M8	78.00	61.30	13.00	44.50	11.50	5.50
5	MC100845-252	10.00	M8	90.00	61.00	13.00	44.50	24.00	4.50

16 mm²

Metric Wire Connector / Two hole 0°

16 mm²

Metric Wire Connector / Two hole 0° / 16 mm²

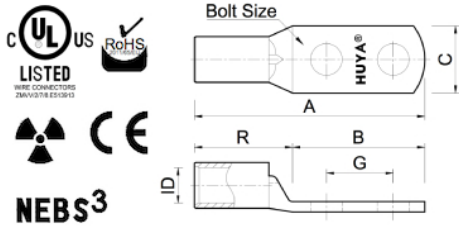

Installation Information

Manufacturer	Tools	Color	Code
T&B	TBM62 BPLT14	--	3
Panduit	CT-2001 CT-930	--	P24
Burndy	PAT600 Y35	--	7
Celestra	A45	--	3

#	Cat.No	Wire Size (mm ²)	Dimension (mm)						
			Bolt Size	A	B	C	G	R	ID
1	MC160625-250	16.00	M6	62.00	41.80	13.00	22.0 – 25.0	14.50	5.50
2	MC160625-251	16.00	M6	63.50	43.00	14.00	22.0 – 25.0	14.50	6.90
3	MC160845-250	16.00	M8	81.50	61.30	13.00	44.50	14.50	5.50
4	MC160845-251	16.00	M8	83.00	62.50	15.50	44.50	14.50	6.90
5	MC160845-252	16.00	M8	94.50	61.30	13.00	44.50	27.20	5.50

25 mm²

Metric Wire Connector / Two hole 0°

25 mm²

Metric Wire Connector / Two hole 0° / 25 mm²

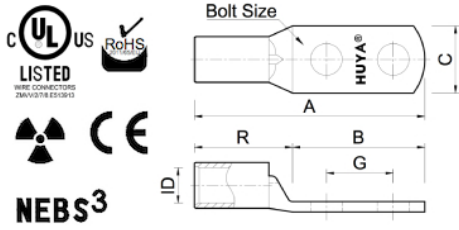

Installation Information

Manufacturer	Tools	Color	Code
T&B	TBM62 BPLT14	--	5
Panduit	CT-2001 CT-930	--	P29
Burndy	PAT600 Y35	--	9
Celestra	A45	--	5

#	Cat.No	Wire Size (mm ²)	Dimension (mm)						
			Bolt Size	A	B	C	G	R	ID
1	MC250825-250	25.00	M8	65.00	43.00	15.50	22.0 – 25.0	15.00	6.90
2	MC250845-252	25.00	M8	96.50	62.50	15.50	44.50	26.70	6.90
3	MC251045-250	25.00	M10	84.50	62.50	15.50	44.50	15.00	6.90
4	MC251045-252	25.00	M10	96.50	62.50	15.50	44.50	26.70	6.90
5	MC251245-250	25.00	M12	92.50	70.50	18.00	44.50	15.00	6.90
6	MC251245-252	25.00	M12	104.50	70.50	19.00	44.50	26.70	7.10

35 mm²

Metric Wire Connector / Two hole 0°

35 mm²

Metric Wire Connector / Two hole 0° / 35 mm²

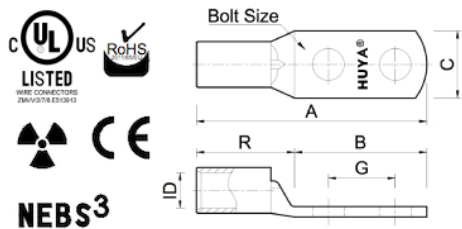

Installation Information

Manufacturer	Tools	Color	Code
T&B	TBM62 BPLT14	--	7
Panduit	CT-2001 CT-930	--	P29
Burndy	PAT600 Y35	--	10
Celestra	A45	--	7

#	Cat.No	Wire Size (mm ²)	Dimension (mm)						
			Bolt Size	A	B	C	G	R	ID
1	MC250825-251	35.00	M8	70.50	45.80	15.50	22.0 – 25.0	17.50	8.20
2	MC250845-251	35.00	M8	90.00	65.30	15.50	44.50	17.50	8.20
3	MC251045-251	35.00	M10	90.00	65.30	15.50	44.50	17.50	8.20
4	MC251245-251	35.00	M12	95.00	70.50	21.50	44.50	17.50	8.20
5	MC350825-250	35.00	M8	70.00	45.80	15.50	22.0 – 25.0	17.50	8.20
6	MC350825-251	35.00	M8	74.00	46.50	18.00	22.0 – 25.0	20.30	9.80
7	MC351045-250	35.00	M10	89.50	65.30	15.50	44.50	17.50	8.20
8	MC351045-251	35.00	M10	93.50	66.00	18.00	44.50	20.30	9.80
9	MC351045-252	35.00	M10	105.00	65.30	15.50	44.50	32.80	8.20
10	MC351245-250	35.00	M12	95.00	70.50	21.50	44.50	17.50	8.20
11	MC351245-251	35.00	M12	97.00	69.50	23.00	44.50	20.30	9.80
12	MC351245-252	35.00	M12	110.50	70.50	18.50	44.50	32.80	8.20

50 mm²

Metric Wire Connector / Two hole 0°

50 mm²

Metric Wire Connector / Two hole 0° / 50 mm²

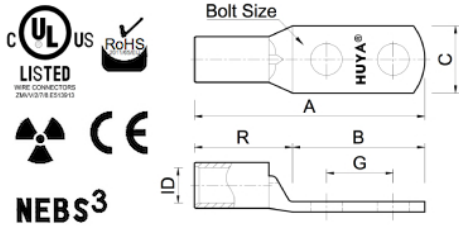

Installation Information

Manufacturer	Tools	Color	Code
T&B	TBM62 BPLT14	--	10
Panduit	CT-2001 CT-930	--	P37
Burndy	PAT600 Y35	--	12
Celestra	A45	--	10

#	Cat.No	Wire Size (mm ²)	Dimension (mm)						
			Bolt Size	A	B	C	G	R	ID
1	MC501025-250	50.00	M10	74.00	46.50	18.00	22.0 – 25.0	20.30	9.80
2	MC501025-251	50.00	M10	81.50	51.00	20.50	22.0 – 25.0	23.30	11.50
3	MC501045-250	50.00	M10	93.50	66.00	18.00	44.50	20.30	9.80
4	MC501045-251	50.00	M10	101.00	70.50	20.80	44.50	23.30	11.50
5	MC501045-252	50.00	M10	109.50	66.00	21.00	44.50	36.60	9.80
6	MC501245-250	50.00	M12	97.00	69.50	23.00	44.50	20.30	9.80
7	MC501245-251	50.00	M12	101.00	70.50	20.80	44.50	23.30	11.50
8	MC501245-252	50.00	M12	113.00	69.50	21.00	44.50	36.60	9.80

70 mm²

Metric Wire Connector / Two hole 0°

70 mm²

Metric Wire Connector / Two hole 0° / 70 mm²

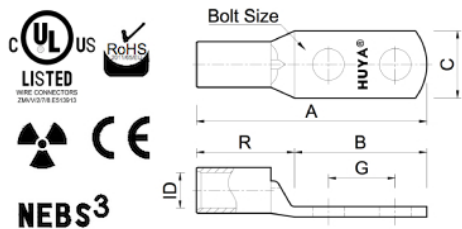

Installation Information

Manufacturer	Tools	Color	Code
T&B	TBM62 BPLT14	--	14
Panduit	CT-2001 CT-930	--	P45
Burndy	PAT600 Y35	--	13
Celestra	A45	--	14

#	Cat.No	Wire Size (mm ²)	Dimension (mm)						
			Bolt Size	A	B	C	G	R	ID
1	MC701025-250	70.00	M10	82.00	50.50	20.80	22.0 – 25.0	23.30	11.50
2	MC701025-251	70.00	M10	86.50	53.50	24.50	22.0 – 25.0	24.50	13.50
3	MC701045-250	70.00	M10	102.00	70.50	20.80	44.50	23.30	11.50
4	MC701045-251	70.00	M10	106.00	73.00	24.50	44.50	24.50	13.50
5	MC701045-252	70.00	M10	117.00	70.50	20.80	44.50	38.00	11.50
6	MC701240-230	70.00	M12	98.50	70.00	25.00	40.00	20.00	13.00
7	MC701245-250	70.00	M12	102.00	70.50	20.80	44.50	23.30	11.50
8	MC701245-251	70.00	M12	106.00	73.00	24.50	44.50	24.50	13.50
9	MC701245-252	70.00	M12	117.00	70.50	20.80	44.50	38.00	11.50

95 mm²

Metric Wire Connector / Two hole 0°

95 mm²

Metric Wire Connector / Two hole 0° / 95 mm²

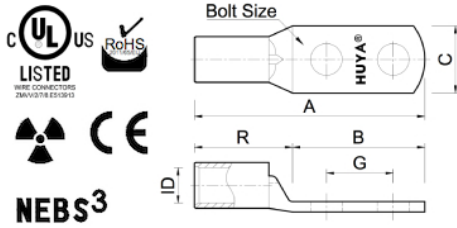

Installation Information

Manufacturer	Tools	Color	Code
T&B	TBM62 BPLT14	--	19
Panduit	CT-2001 CT-930	--	P54
Burndy	MY29 Y644M	--	14
Celestra	A45	--	19

#	Cat.No	Wire Size (mm ²)	Dimension (mm)						
			Bolt Size	A	B	C	G	R	ID
1	MC951025-250	95.00	M10	86.50	53.00	24.50	22.0 – 25.0	24.50	13.50
2	MC951025-251	95.00	M10	88.50	55.00	27.50	22.0 – 25.0	24.50	15.20
3	MC951240-230	95.00	M12	102.00	70.00	29.00	40.00	23.00	15.00
4	MC951245-250	95.00	M12	106.50	73.00	24.50	44.50	24.50	13.50
5	MC951245-251	95.00	M12	108.00	74.50	27.50	44.50	24.50	15.20
6	MC951245-252	95.00	M12	125.00	73.00	24.50	44.50	43.00	13.50
7	MC951445-250	95.00	M14	106.50	73.00	24.50	44.50	24.50	13.50
8	MC951445-251	95.00	M14	108.00	74.50	27.50	44.50	24.50	15.20
9	MC951445-252	95.00	M14	125.00	73.00	24.50	44.50	43.00	13.50

120 mm²

Metric Wire Connector / Two hole 0°

120 mm²

Metric Wire Connector / Two hole 0° / 120 mm²

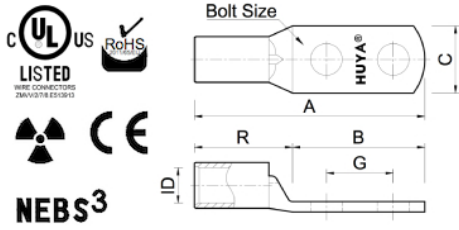

Installation Information

Manufacturer	Tools	Color	Code
T&B	TBM62 BPLT14	--	24
Panduit	CT-2001 CT-930	--	P62
Burndy	PAT600 Y35	--	15
Celestra	A45	--	24

#	Cat.No	Wire Size (mm ²)	Dimension (mm)						
			Bolt Size	A	B	C	G	R	ID
1	MC121025-250	120.00	M10	88.50	54.50	27.50	22.0 – 25.0	24.50	15.20
2	MC121025-251	120.00	M10	96.50	59.50	30.50	22.0 – 25.0	27.50	16.50
3	MC121240-230	120.00	M12	105.50	71.00	32.00	40.00	25.00	17.00
4	MC121245-250	120.00	M12	108.50	74.50	27.50	44.50	24.50	15.20
5	MC121245-251	120.00	M12	116.00	79.00	30.50	44.50	27.50	16.50
6	MC121245-252	120.00	M12	124.00	74.50	27.50	44.50	39.70	15.20
7	MC121445-250	120.00	M14	108.50	74.50	27.50	44.50	24.50	15.20
8	MC121445-251	120.00	M14	120.00	83.00	30.50	44.50	27.50	16.50
9	MC121445-252	120.00	M14	124.00	74.50	27.50	44.50	39.70	15.20

150 mm²

Metric Wire Connector / Two hole 0°

150 mm²

Metric Wire Connector / Two hole 0° / 150 mm²

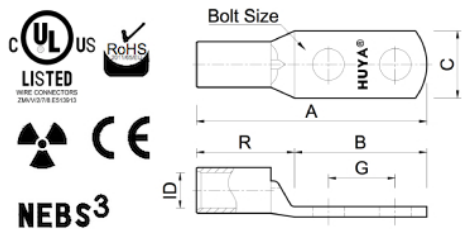

Installation Information

Manufacturer	Tools	Color	Code
T&B	TBM62 BPLT14	--	30
Panduit	CT-2001 CT-930	--	P66
Burndy	PAT600 Y35	--	17
Celestra	A45	--	30

#	Cat.No	Wire Size (mm ²)	Dimension (mm)						
			Bolt Size	A	B	C	G	R	ID
1	MC151025-250	150.00	M10	97.50	59.00	30.50	22.0 – 25.0	27.50	16.50
2	MC151025-251	150.00	M10	102.00	63.00	33.50	22.0 – 25.0	28.20	18.60
3	MC151240-230	150.00	M12	112.00	71.00	36.00	40.00	30.00	19.00
4	MC151245-250	150.00	M12	117.00	79.00	30.50	44.50	27.50	16.50
5	MC151245-251	150.00	M12	122.00	83.00	33.50	44.50	28.20	18.60
6	MC151245-252	150.00	M12	147.00	79.00	30.50	44.50	57.00	16.50
7	MC151445-250	150.00	M14	121.50	83.00	30.50	44.50	27.50	16.50
8	MC151445-251	150.00	M14	122.00	83.00	33.50	44.50	28.20	18.60
9	MC151445-252	150.00	M14	151.00	83.00	30.50	44.50	57.00	16.50

185 mm²

Metric Wire Connector / Two hole 0°

185 mm²

Metric Wire Connector / Two hole 0° / 185 mm²

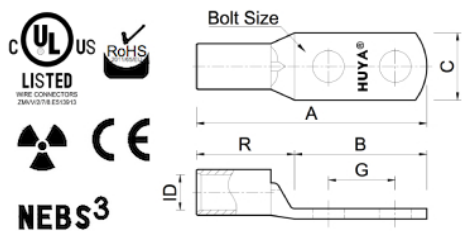

Installation Information

Manufacturer	Tools	Color	Code
T&B	TBM62 BPLT14	--	37
Panduit	CT-2001 CT-930	--	P76
Burndy	PAT600 Y35	--	18
Celestra	A45	--	37

#	Cat.No	Wire Size (mm ²)	Dimension (mm)						
			Bolt Size	A	B	C	G	R	ID
1	MC181025-250	185.00	M10	101.50	60.00	33.50	22.0 – 25.0	28.20	18.60
2	MC181025-251	185.00	M10	114.00	65.50	37.50	22.0 – 25.0	35.00	20.80
3	MC181240-230	185.00	M12	120.50	72.00	39.00	40.00	35.00	21.00
4	MC181245-250	185.00	M12	122.00	80.50	33.50	44.50	28.20	18.60
5	MC181245-251	185.00	M12	133.50	85.00	37.50	44.50	35.00	20.80
6	MC181245-252	185.00	M12	148.00	78.50	33.50	44.50	56.30	18.60
7	MC181445-250	185.00	M14	124.50	83.00	33.50	44.50	28.20	18.60
8	MC181445-251	185.00	M14	133.50	85.00	37.50	44.50	35.00	20.80
9	MC181445-252	185.00	M14	152.50	83.00	33.50	44.50	56.30	18.60

240 mm²

Metric Wire Connector / Two hole 0°

240 mm²

Metric Wire Connector / Two hole 0° / 240 mm²

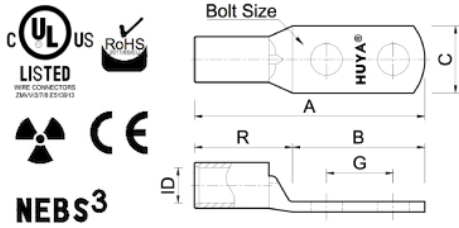

Installation Information

Manufacturer	Tools	Color	Code
T&B	TBM62 BPLT14	--	48
Panduit	CT-2001 CT-930	--	P87
Burndy	PAT600 Y35	--	20
Celestra	A45	--	48

#	Cat.No	Wire Size (mm ²)	Dimension (mm)						
			Bolt Size	A	B	C	G	R	ID
1	MC241025-250	240.00	M10	116.00	65.00	37.50	22.0 – 25.0	35.00	20.80
2	MC241025-251	240.00	M10	123.00	67.00	42.50	22.0 – 25.0	40.30	23.50
3	MC241240-230	240.00	M12	124.00	73.00	42.00	40.00	35.00	22.50
4	MC241245-250	240.00	M12	136.00	85.00	37.50	44.50	35.00	20.80
5	MC241245-251	240.00	M12	142.50	86.50	42.50	44.50	40.30	23.50
6	MC241245-252	240.00	M12	164.50	85.00	37.50	44.50	63.50	20.80
7	MC241445-250	240.00	M14	136.00	85.00	37.50	44.50	35.00	20.80
8	MC241445-251	240.00	M14	142.50	86.50	42.50	44.50	40.30	23.50
9	MC241445-252	240.00	M14	164.50	85.00	37.50	44.50	63.50	20.80

300 mm²

Metric Wire Connector / Two hole 0°

300 mm²

Metric Wire Connector / Two hole 0° / 300 mm²

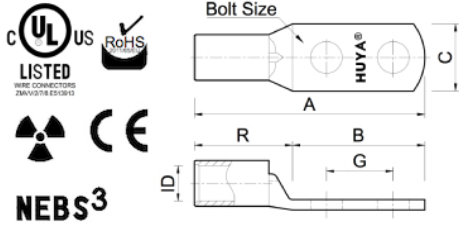

Installation Information

Manufacturer	Tools	Color	Code
T&B	BPLT14	--	60
Panduit	CT-930 CT-940	--	P94
Burndy	PAT750 Y35	--	22
Celestra	A45	--	60

#	Cat.No	Wire Size (mm ²)	Dimension (mm)						
			Bolt Size	A	B	C	G	R	ID
1	MC311240-230	300.00	M12	134.50	74.00	45.00	40.00	42.00	24.50
2	MC311245-250	300.00	M12	145.50	86.50	42.50	44.50	40.30	23.50
3	MC311245-251	300.00	M12	158.00	94.50	48.00	44.50	44.80	26.20
4	MC311245-252	300.00	M12	173.50	86.50	42.50	44.50	68.40	23.50
5	MC311445-250	300.00	M14	145.50	86.50	42.50	44.50	40.30	23.50
6	MC311445-251	300.00	M14	158.00	94.50	48.00	44.50	44.80	26.20
7	MC311445-252	300.00	M14	173.50	86.50	42.50	44.50	68.40	23.50
8	MCX311245-252	300.00	M12	187.50	94.50	48.00	44.50	73.00	26.20
9	MCX311445-252	300.00	M14	187.50	94.50	48.00	44.50	73.00	26.20

400 mm²

Metric Wire Connector / Two hole 0°

400 mm²

Metric Wire Connector / Two hole 0° / 400 mm²

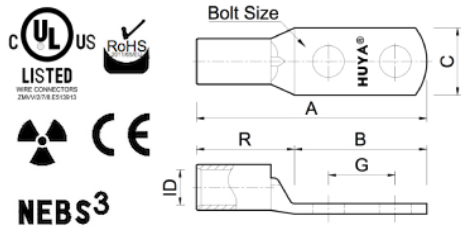

Installation Information

Manufacturer	Tools	Color	Code
T&B	BPLT14 TBM26	--	80
Panduit	CT-930 CT-940	--	P106
Burndy	PAT750 Y35	--	24
Celestra	A45	--	80

#	Cat.No	Wire Size (mm ²)	Dimension (mm)						
			Bolt Size	A	B	C	G	R	ID
1	MC411240-230	400.00	M12	145.00	75.00	56.00	40.00	50.00	30.00
2	MC411245-250	400.00	M12	159.50	94.50	49.50	44.50	44.80	27.00
3	MC411445-250	400.00	M14	159.50	94.50	49.50	44.50	44.80	27.00
4	MC411645-250	400.00	M16	159.50	94.50	49.50	44.50	44.80	27.00
5	MCX411245-252	400.00	M12	180.00	94.50	49.50	44.50	65.20	27.00
6	MCX411445-252	400.00	M14	180.00	94.50	49.50	44.50	65.20	27.00
7	MCX411645-252	400.00	M16	180.00	94.50	49.50	44.50	65.20	27.00

500 mm²

Metric Wire Connector / Two hole 0°

500 mm²

Metric Wire Connector / Two hole 0° / 500 mm²

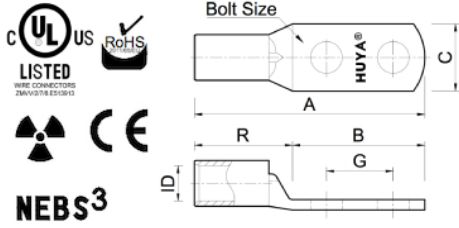

Installation Information

Manufacturer	Tools	Color	Code
T&B	TBM26 TBM60	--	100
Panduit	CT-930 CT-940	--	P125
Burndy	PAT750 Y35	--	L115
Celestra	A45	--	100

#	Cat.No	Wire Size (mm ²)	Dimension (mm)						
			Bolt Size	A	B	C	G	R	ID
1	MC511245-250	500.00	M12	166.00	98.50	57.50	44.50	46.50	31.00
2	MC511445-250	500.00	M14	166.00	98.50	57.50	44.50	46.50	31.00
3	MC511645-250	500.00	M16	166.00	98.50	57.50	44.50	46.50	31.00
4	MCX511245-252	500.00	M12	195.50	98.50	57.50	44.50	76.20	31.00
5	MCX511445-252	500.00	M14	195.50	98.50	57.50	44.50	76.20	31.00
6	MCX511645-252	500.00	M16	195.50	98.50	57.50	44.50	76.20	31.00

630 mm²

Metric Wire Connector / Two hole 0°

630 mm²

Metric Wire Connector / Two hole 0° / 630 mm²

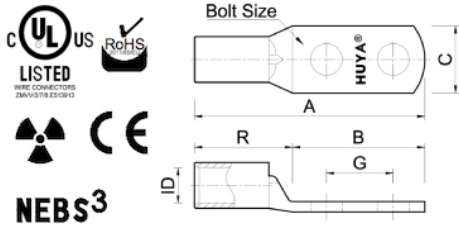

Installation Information

Manufacturer	Tools	Color	Code
T&B	TBM26 TBM60	--	120
Panduit	CT-930 CT-940	--	P125
Burndy	PAT750 Y35	--	29
Celestra	A45	--	120

#	Cat.No	Wire Size (mm ²)	Dimension (mm)						
			Bolt Size	A	B	C	G	R	ID
1	MC631245-250	630.00	M12	181.00	100.50	63.50	44.50	56.20	34.50
2	MC631445-250	630.00	M14	181.00	100.50	63.50	44.50	56.20	34.50
3	MC631645-250	630.00	M16	181.00	100.50	63.50	44.50	56.20	34.50
4	MCX631245-252	630.00	M12	209.00	100.50	63.50	44.50	84.30	34.50
5	MCX631445-252	630.00	M14	209.00	100.50	63.50	44.50	84.30	34.50
6	MCX631645-252	630.00	M16	209.00	100.50	63.50	44.50	84.30	34.50

10 mm²

Metric Wire Connector / None hole 0°

10 mm²

Metric Wire Connector / None hole 0° / 10 mm²

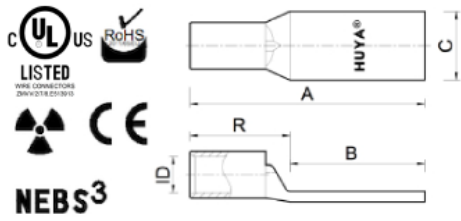

Installation Information

Manufacturer	Tools	Color	Code
T&B	TBM62 BPLT14	--	2
Panduit	CT-2001 CT-930	--	P21
Burndy	PAT600 Y35	--	49
Celestra	A45	--	2

#	Cat.No	Wire Size (mm ²)	Dimension (mm)				
			A	B	C	R	ID
1	MC1000NH-250	10.00	75.50	59.00	15.00	16.30	4.40
2	MC1000NH-251	10.00	81.50	63.50	15.00	16.30	5.50
3	MC1000NH-252	10.00	90.00	61.00	15.00	28.80	4.40

16 mm²

Metric Wire Connector / None hole 0°

16 mm²

Metric Wire Connector / None hole 0° / 16 mm²

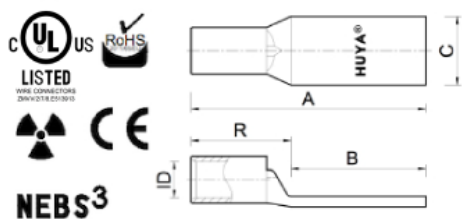

Installation Information

Manufacturer	Tools	Color	Code
T&B	TBM62 BPLT14	--	3
Panduit	CT-2001 CT-930	--	P24
Burndy	PAT600 Y35	--	7
Celestra	A45	--	3

#	Cat.No	Wire Size (mm ²)	Dimension (mm)				
			A	B	C	R	ID
1	MC1600NH-250	16.00	81.50	60.50	15.00	19.60	5.50
2	MC1600NH-251	16.00	89.50	67.00	20.00	19.60	7.10
3	MC1600NH-252	16.00	94.50	60.90	15.00	32.30	5.50

25 mm²

Metric Wire Connector / None hole 0°

25 mm²

Metric Wire Connector / None hole 0° / 25 mm²

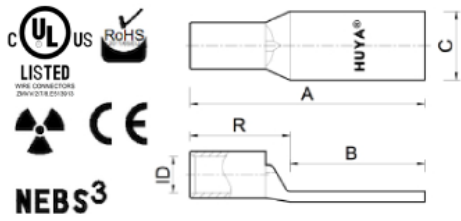

Installation Information

Manufacturer	Tools	Color	Code
T&B	TBM62 BPLT14	--	5
Panduit	CT-2001 CT-930	--	P29
Burndy	PAT600 Y35	--	9
Celestra	A45	--	5

#	Cat.No	Wire Size (mm ²)	Dimension (mm)				
			A	B	C	R	ID
1	MC2500NH-250	25.00	89.50	66.50	20.00	21.50	7.10
2	MC2500NH-251	35.00	92.50	67.70	21.50	24.00	8.20
3	MC2500NH-252	25.00	104.50	70.50	19.00	33.20	7.10

35 mm²

Metric Wire Connector / None hole 0°

35 mm²

Metric Wire Connector / None hole 0° / 35 mm²

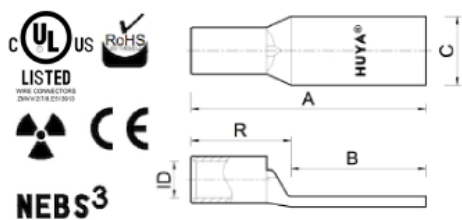

Installation Information

Manufacturer	Tools	Color	Code
T&B	TBM62 BPLT14	--	7
Panduit	CT-2001 CT-930	--	P29
Burndy	PAT600 Y35	--	10
Celestra	A45	--	7

#	Cat.No	Wire Size (mm ²)	Dimension (mm)				
			A	B	C	R	ID
1	MC3500NH-250	35.00	92.50	67.70	21.50	24.00	8.20
2	MC3500NH-251	35.00	94.50	67.30	23.00	26.80	9.80
3	MC3500NH-252	35.00	110.60	70.50	18.50	39.30	8.20

50 mm²

Metric Wire Connector / None hole 0°

50 mm²

Metric Wire Connector / None hole 0° / 50 mm²

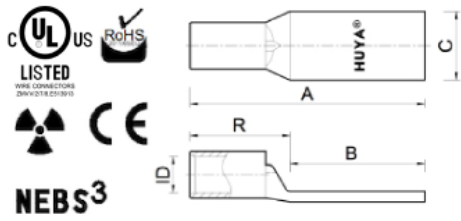

Installation Information

Manufacturer	Tools	Color	Code
T&B	TBM62 BPLT14	--	10
Panduit	CT-2001 CT-930	--	P37
Burndy	PAT600 Y35	--	12
Celestra	A45	--	10

#	Cat.No	Wire Size (mm ²)	Dimension (mm)				
			A	B	C	R	ID
1	MC5000NH-250	50.00	94.50	67.30	23.00	27.50	9.80
2	MC5000NH-251	50.00	98.00	66.20	20.80	30.50	11.50
3	MC5000NH-252	50.00	113.00	69.50	21.00	43.80	9.80

70 mm²

Metric Wire Connector / None hole 0°

70 mm²

Metric Wire Connector / None hole 0° / 70 mm²

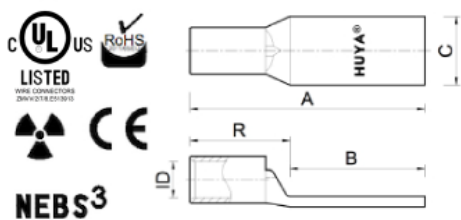

Installation Information

Manufacturer	Tools	Color	Code
T&B	TBM62 BPLT14	--	14
Panduit	CT-2001 CT-930	--	P45
Burndy	PAT600 Y35	--	13
Celestra	A45	--	14

#	Cat.No	Wire Size (mm ²)	Dimension (mm)				
			A	B	C	R	ID
1	MC7000NH-250	70.00	98.00	66.20	20.80	31.40	11.50
2	MC7000NH-251	70.00	105.00	71.50	24.50	32.60	13.50
3	MC7000NH-252	70.00	117.00	70.50	20.80	46.10	11.50

95 mm²

Metric Wire Connector / None hole 0°

95 mm²

Metric Wire Connector / None hole 0° / 95 mm²

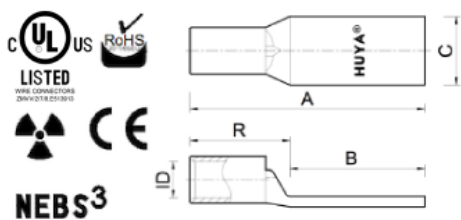

Installation Information

Manufacturer	Tools	Color	Code
T&B	TBM62 BPLT14	--	19
Panduit	CT-2001 CT-930	--	P54
Burndy	MY29 Y644M	--	14
Celestra	A45	--	19

#	Cat.No	Wire Size (mm ²)	Dimension (mm)				
			A	B	C	R	ID
1	MC9500NH-250	95.00	105.00	71.50	24.50	32.60	13.50
2	MC9500NH-251	95.00	109.50	75.20	27.50	32.60	15.20
3	MC9500NH-252	95.00	125.00	73.00	24.50	51.10	13.50

120 mm²

Metric Wire Connector / None hole 0°

120 mm²

Metric Wire Connector / None hole 0° / 120 mm²

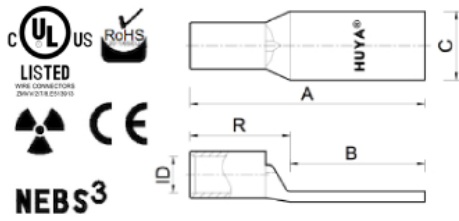

Installation Information

Manufacturer	Tools	Color	Code
T&B	TBM62 BPLT14	--	24
Panduit	CT-2001 CT-930	--	P62
Burndy	PAT600 Y35	--	15
Celestra	A45	--	24

#	Cat.No	Wire Size (mm ²)	Dimension (mm)				
			A	B	C	R	ID
1	MC1200NH-250	120.00	109.50	75.20	27.50	33.40	15.20
2	MC1200NH-251	120.00	118.50	80.00	30.50	36.40	16.50
3	MC1200NH-252	120.00	124.00	74.50	27.50	48.60	15.20

150 mm²

Metric Wire Connector / None hole 0°

150 mm²

Metric Wire Connector / None hole 0° / 150 mm²

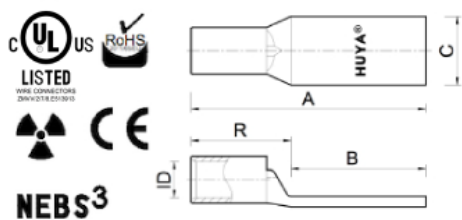

Installation Information

Manufacturer	Tools	Color	Code
T&B	TBM62 BPLT14	--	30
Panduit	CT-2001 CT-930	--	P66
Burndy	PAT600 Y35	--	17
Celestra	A45	--	30

#	Cat.No	Wire Size (mm ²)	Dimension (mm)				
			A	B	C	R	ID
1	MC1500NH-250	150.00	118.50	80.00	30.50	37.70	16.50
2	MC1500NH-251	150.00	121.50	80.10	33.50	38.40	18.60
3	MC1500NH-252	150.00	151.00	80.00	30.50	67.20	16.50

185 mm²

Metric Wire Connector / None hole 0°

185 mm²

Metric Wire Connector / None hole 0° / 185 mm²

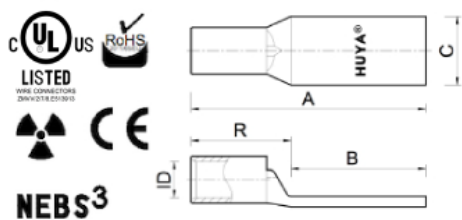

Installation Information

Manufacturer	Tools	Color	Code
T&B	TBM62 BPLT14	--	37
Panduit	CT-2001 CT-930	--	P76
Burndy	PAT600 Y35	--	18
Celestra	A45	--	37

#	Cat.No	Wire Size (mm ²)	Dimension (mm)				
			A	B	C	R	ID
1	MC1800NH-250	185.00	121.50	80.10	33.50	40.90	18.60
2	MC1800NH-251	185.00	131.00	80.00	37.50	47.70	20.80
3	MC1800NH-252	185.00	152.50	83.00	33.50	69.00	18.60

300 mm²

Metric Wire Connector / None hole 0°

300 mm²

Metric Wire Connector / None hole 0° / 300 mm²

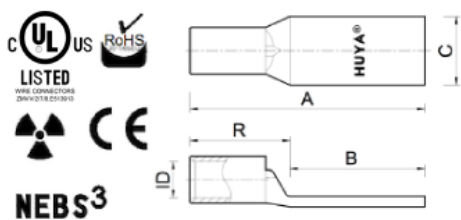

Installation Information

Manufacturer	Tools	Color	Code
T&B	BPLT14	--	60
Panduit	CT-930 CT-940	--	P94
Burndy	PAT750 Y35	--	22
Celestra	A45	--	60

#	Cat.No	Wire Size (mm ²)	Dimension (mm)				
			A	B	C	R	ID
1	MC3100NH-250	300.00	139.00	80.10	42.50	58.10	23.50
2	MC3100NH-251	300.00	151.50	86.70	48.00	62.60	26.20
3	MC3100NH-252	300.00	173.50	86.50	42.50	86.20	23.50
4	MCX3100NH-252	300.00	187.50	94.50	48.00	90.80	26.20

400 mm²

Metric Wire Connector / None hole 0°

400 mm²

Metric Wire Connector / None hole 0° / 400 mm²

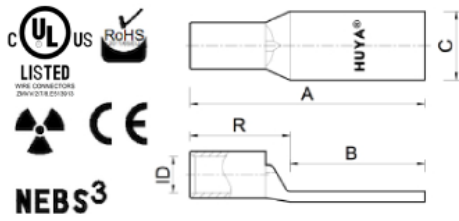

Installation Information

Manufacturer	Tools	Color	Code
T&B	BPLT14 TBM26	--	80
Panduit	CT-930 CT-940	--	P106
Burndy	PAT750 Y35	--	24
Celestra	A45	--	80

#	Cat.No	Wire Size (mm ²)	Dimension (mm)				
			A	B	C	R	ID
1	MC4100-230	400.00	125.00	55.00	55.00	71.30	30.00
2	MC4100NH-250	400.00	151.50	86.40	49.50	66.10	27.00
3	MCX4100NH-252	400.00	180.00	94.50	49.50	86.50	27.00

500 mm²

Metric Wire Connector / None hole 0°

500 mm²

Metric Wire Connector / None hole 0° / 500 mm²

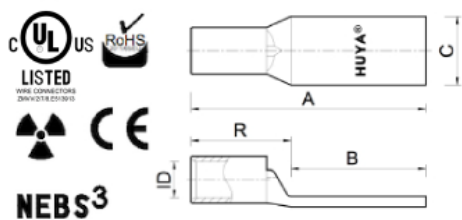

Installation Information

Manufacturer	Tools	Color	Code
T&B	TBM26 TBM60	--	100
Panduit	CT-930 CT-940	--	P125
Burndy	PAT750 Y35	--	L115
Celestra	A45	--	100

#	Cat.No	Wire Size (mm ²)	Dimension (mm)				
			A	B	C	R	ID
1	MC5100-230	500.00	146.00	60.00	61.00	88.30	33.00
2	MC5100-231	500.00	146.00	60.00	58.00	88.30	31.00
3	MC5100-232	500.00	156.00	70.00	58.00	88.30	31.00
4	MC5100NH-250	500.00	166.00	98.50	57.50	69.80	31.00
5	MCX5100NH-252	500.00	195.50	98.50	57.50	99.50	31.00

630 mm²

Metric Wire Connector / None hole 0°

630 mm²

Metric Wire Connector / None hole 0° / 630 mm²

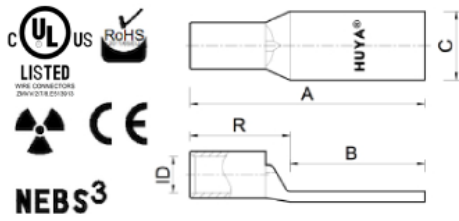

Installation Information

Manufacturer	Tools	Color	Code
T&B	TBM26 TBM60	--	120
Panduit	CT-930 CT-940	--	P125
Burndy	PAT750 Y35	--	29
Celestra	A45	--	120

#	Cat.No	Wire Size (mm ²)	Dimension (mm)				
			A	B	C	R	ID
1	MC6300-231	630.00	160.00	70.00	65.00	88.30	34.00
2	MC6300-232	630.00	164.00	75.00	65.00	88.30	34.00
3	MC6300NH-250	630.00	175.50	95.00	63.50	79.50	34.50
4	MCX6300NH-252	630.00	209.00	100.50	63.50	107.60	34.50

6 mm²

Metric Wire Connector / Splices

6 mm²

Metric Wire Connector / Splices / 6 mm²

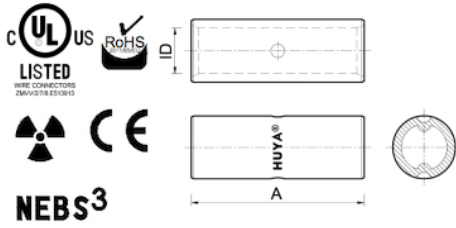

Installation Information

Manufacturer	Tools	Color	Code
T&B	TBM62	--	--
Panduit	CT-100 CT1701	--	P10
Burndy	Y10D Y10R4BY	--	--
Celestra	A45	--	--

#	Cat.No	Wire Size (mm ²)	Dimension (mm)	
			A	ID
1	MS06	6.00	15.00	3.60
2	MS06-30	6.00	19.00	4.00

10 mm²

Metric Wire Connector / Splices

10 mm²

Metric Wire Connector / Splices / 10 mm²

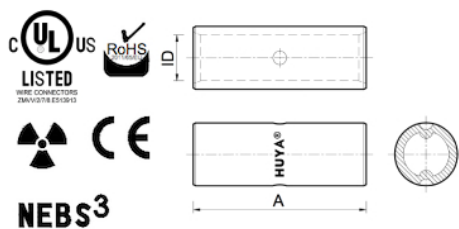

Installation Information

Manufacturer	Tools	Color	Code
T&B	TBM62 BPLT14	--	2
Panduit	CT-2001 CT-930	--	P21
Burndy	PAT600 Y35	--	49
Celestra	A45	--	2

#	Cat.No	Wire Size (mm ²)	Dimension (mm)	
			A	ID
1	MS10	10.00	25.00	4.60
2	MS10-30	10.00	30.00	5.00
3	MS10-32	10.00	30.00	4.50
4	MS10-50	10.00	30.00	4.50
5	MS10-51	10.00	35.00	5.50

16 mm²

Metric Wire Connector / Splices

16 mm²

Metric Wire Connector / Splices / 16 mm²

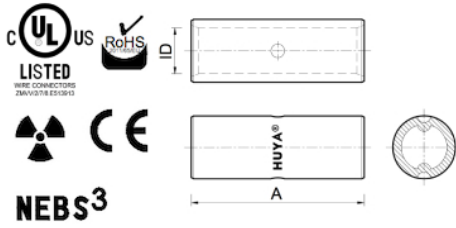

Installation Information

Manufacturer	Tools	Color	Code
T&B	TBM62 BPLT14	--	3
Panduit	CT-2001 CT-930	--	P24
Burndy	PAT600 Y35	--	7
Celestra	A45	--	3

#	Cat.No	Wire Size (mm ²)	Dimension (mm)	
			A	ID
1	MS16	16.00	27.00	5.80
2	MS16-30	16.00	35.00	6.00
3	MS16-31	16.00	35.00	5.40
4	MS16-32	16.00	35.00	5.50
5	MS16-50	16.00	35.00	5.50
6	MS16-51	16.00	49.00	6.90

25 mm²

Metric Wire Connector / Splices

25 mm²

Metric Wire Connector / Splices / 25 mm²

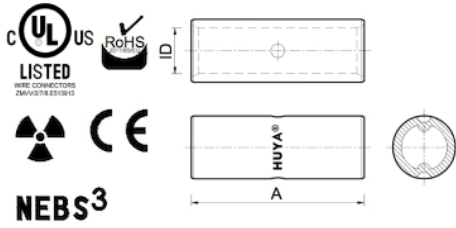

Installation Information

Manufacturer	Tools	Color	Code
T&B	TBM62 BPLT14	--	5
Panduit	CT-2001 CT-930	--	P29
Burndy	PAT600 Y35	--	9
Celestra	A45	--	5

#	Cat.No	Wire Size (mm ²)	Dimension (mm)	
			A	ID
1	MS25	25.00	29.00	7.00
2	MS25-30	25.00	35.00	8.00
3	MS25-31	25.00	30.00	6.70
4	MS25-32	25.00	40.00	7.00
5	MS25-50	25.00	36.00	6.90
6	MS25-51	25.00	36.00	8.20

35 mm²

Metric Wire Connector / Splices

35 mm²

Metric Wire Connector / Splices / 35 mm²

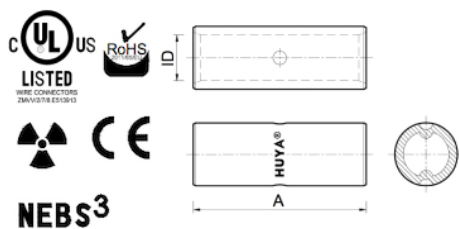

Installation Information

Manufacturer	Tools	Color	Code
T&B	TBM62 BPLT14	--	7
Panduit	CT-2001 CT-930	--	P29
Burndy	PAT600 Y35	--	10
Celestra	A45	--	7

#	Cat.No	Wire Size (mm ²)	Dimension (mm)	
			A	ID
1	MS35	35.00	33.00	8.90
2	MS35-30	35.00	35.00	9.00
3	MS35-31	35.00	35.00	8.00
4	MS35-32	35.00	45.00	8.50
5	MS35-50	35.00	36.00	8.20
6	MS35-51	35.00	49.00	9.80

50 mm²

Metric Wire Connector / Splices

50 mm²

Metric Wire Connector / Splices / 50 mm²

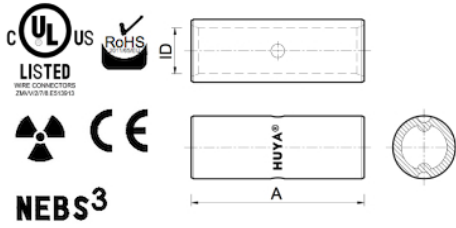

Installation Information

Manufacturer	Tools	Color	Code
T&B	TBM62 BPLT14	--	7
Panduit	CT-2001 CT-930	--	P29
Burndy	PAT600 Y35	--	10
Celestra	A45	--	7

#	Cat.No	Wire Size (mm ²)	Dimension (mm)	
			A	ID
1	MS50	50.00	37.00	10.00
2	MS50-30	50.00	45.00	11.00
3	MS50-31	50.00	40.00	9.50
4	MS50-32	50.00	50.00	10.00
5	MS50-50	50.00	49.00	9.80
6	MS50-51	50.00	57.00	11.50

70 mm²

Metric Wire Connector / Splices

70 mm²

Metric Wire Connector / Splices / 70 mm²

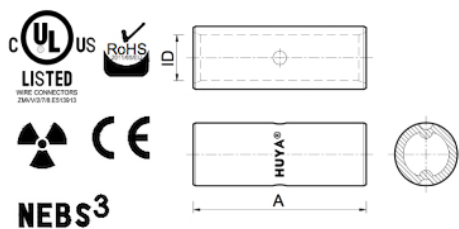

Installation Information

Manufacturer	Tools	Color	Code
T&B	TBM62 BPLT14	--	14
Panduit	CT-2001 CT-930	--	P45
Burndy	PAT600 Y35	--	13
Celestra	A45	--	14

#	Cat.No	Wire Size (mm ²)	Dimension (mm)	
			A	ID
1	MS70	70.00	39.00	11.30
2	MS70-30	70.00	45.00	13.00
3	MS70-31	70.00	45.00	11.30
4	MS70-32	70.00	55.00	12.00
5	MS70-50	70.00	52.00	11.50
6	MS70-51	70.00	54.00	13.50

95 mm²

Metric Wire Connector / Splices

95 mm²

Metric Wire Connector / Splices / 95 mm²

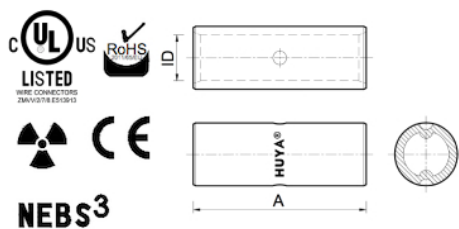

Installation Information

Manufacturer	Tools	Color	Code
T&B	TBM62 BPLT14	--	19
Panduit	CT-2001 CT-930	--	P54
Burndy	MY29 Y644M	--	14
Celestra	A45	--	19

#	Cat.No	Wire Size (mm ²)	Dimension (mm)	
			A	ID
1	MS95	95.00	43.00	13.50
2	MS95-30	95.00	45.00	15.00
3	MS95-31	95.00	55.00	13.00
4	MS95-32	95.00	60.00	13.50
5	MS95-50	95.00	54.00	13.50
6	MS95-51	95.00	57.00	15.20

120 mm²

Metric Wire Connector / Splices

120 mm²

Metric Wire Connector / Splices / 120 mm²

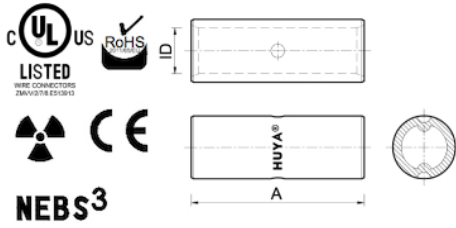

Installation Information

Manufacturer	Tools	Color	Code
T&B	TBM62 BPLT14	--	24
Panduit	CT-2001 CT-930	--	P62
Burndy	PAT600 Y35	--	15
Celestra	A45	--	24

#	Cat.No	Wire Size (mm ²)	Dimension (mm)	
			A	ID
1	MS12	120.00	47.00	15.20
2	MS12-30	120.00	55.00	17.00
3	MS12-31	120.00	60.00	15.00
4	MS12-32	120.00	60.00	15.00
5	MS12-50	120.00	57.00	15.20
6	MS12-51	120.00	57.00	16.50

150 mm²

Metric Wire Connector / Splices

150 mm²

Metric Wire Connector / Splices / 150 mm²

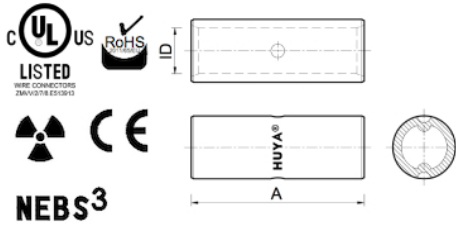

Installation Information

Manufacturer	Tools	Color	Code
T&B	TBM62 BPLT14	--	30
Panduit	CT-2001 CT-930	--	P66
Burndy	PAT600 Y35	--	17
Celestra	A45	--	30

#	Cat.No	Wire Size (mm ²)	Dimension (mm)	
			A	ID
1	MS15	150.00	58.00	16.70
2	MS15-30	150.00	65.00	19.00
3	MS15-31	150.00	65.00	17.00
4	MS15-32	150.00	65.00	17.00
5	MS15-50	150.00	57.00	16.50
6	MS15-51	150.00	61.00	18.60

185 mm²

Metric Wire Connector / Splices

185 mm²

Metric Wire Connector / Splices / 185 mm²

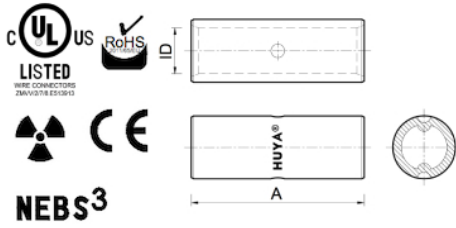

Installation Information

Manufacturer	Tools	Color	Code
T&B	TBM62 BPLT14	--	37
Panduit	CT-2001 CT-930	--	P76
Burndy	PAT600 Y35	--	18
Celestra	A45	--	37

#	Cat.No	Wire Size (mm ²)	Dimension (mm)	
			A	ID
1	MS18	185.00	64.00	19.20
2	MS18-30	185.00	70.00	21.00
3	MS18-31	185.00	70.00	19.00
4	MS18-32	185.00	75.00	19.00
5	MS18-50	185.00	61.00	18.60
6	MS18-51	185.00	72.00	20.80

240 mm²

Metric Wire Connector / Splices

240 mm²

Metric Wire Connector / Splices / 240 mm²

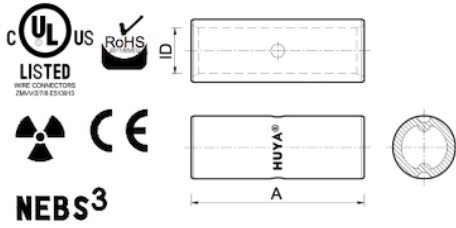

Installation Information

Manufacturer	Tools	Color	Code
T&B	TBM62 BPLT14	--	48
Panduit	CT-2001 CT-930	--	P87
Burndy	PAT600 Y35	--	20
Celestra	A45	--	48

#	Cat.No	Wire Size (mm ²)	Dimension (mm)	
			A	ID
1	MS24	240.00	75.00	21.10
2	MS24-30	240.00	70.00	22.50
3	MS24-31	240.00	70.00	21.00
4	MS24-32	240.00	85.00	21.00
5	MS24-50	240.00	72.00	20.80
6	MS24-51	240.00	75.00	23.50

300 mm²

Metric Wire Connector / Splices

300 mm²

Metric Wire Connector / Splices / 300 mm²

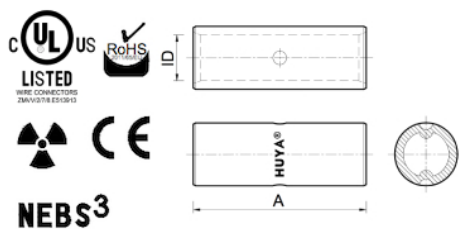

Installation Information

Manufacturer	Tools	Color	Code
T&B	BPLT14	--	60
Panduit	CT-930 CT-940	--	P94
Burndy	PAT750 Y35	--	22
Celestra	A45	--	60

#	Cat.No	Wire Size (mm ²)	Dimension (mm)	
			A	ID
1	MS31	300.00	90.00	23.70
2	MS31-30	300.00	75.00	24.50
3	MS31-31	300.00	90.00	24.00
4	MS31-32	300.00	90.00	24.00
5	MS31-50	300.00	75.00	23.50
6	MS31-51	300.00	95.00	26.20

400 mm²

Metric Wire Connector / Splices

400 mm²

Metric Wire Connector / Splices / 400 mm²

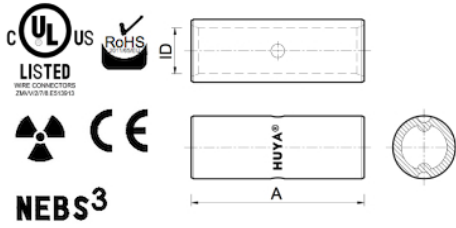

Installation Information

Manufacturer	Tools	Color	Code
T&B	BPLT14 TBM26	--	80
Panduit	CT-930 CT-940	--	P106
Burndy	PAT750 Y35	--	24
Celestra	A45	--	80

#	Cat.No	Wire Size (mm ²)	Dimension (mm)	
			A	ID
1	MS41	400.00	94.00	27.00
2	MS41-30	400.00	100.00	30.00
3	MS41-31	400.00	90.00	26.00
4	MS41-32	400.00	90.00	26.00
5	MS41-50	400.00	95.00	27.00

500 mm²

Metric Wire Connector / Splices

500 mm²

Metric Wire Connector / Splices / 500 mm²

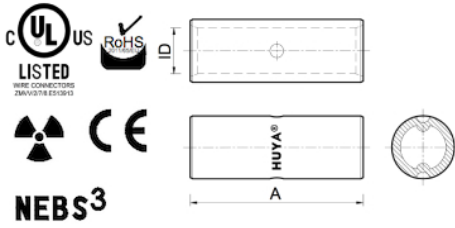

Installation Information

Manufacturer	Tools	Color	Code
T&B	TBM26 TBM60	--	100
Panduit	CT-930 CT-940	--	P125
Burndy	PAT750 Y35	--	L115
Celestra	A45	--	100

#	Cat.No	Wire Size (mm ²)	Dimension (mm)	
			A	ID
1	MS51	500.00	98.00	30.30
2	MS51-30	500.00	135.00	33.00
3	MS51-31	500.00	135.00	31.00
4	MS51-32	500.00	135.00	31.00
5	MS51-50	500.00	96.00	31.00

630 mm²

Metric Wire Connector / Splices

630 mm²

Metric Wire Connector / Splices / 630 mm²

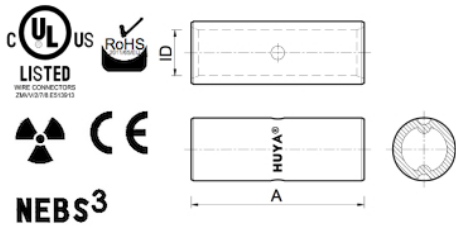

Installation Information

Manufacturer	Tools	Color	Code
T&B	TBM26 TBM60	--	120
Panduit	CT-930 CT-940	--	P125
Burndy	PAT750 Y35	--	29
Celestra	A45	--	120

#	Cat.No	Wire Size (mm ²)	Dimension (mm)	
			A	ID
1	MS63	630.00	105.00	33.40
2	MS63-30	630.00	175.00	39.00
3	MS63-31	630.00	135.00	34.00
4	MS63-32	630.00	135.00	34.00
5	MS63-50	630.00	131.00	34.50

One - Hole Stand Barrel

Metric Wire Connector / Narrow Tongue

One - Hole Stand Barrel

Metric Wire Connector / Narrow Tongue / One - Hole Stand Barrel

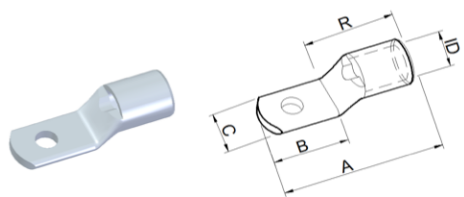

Installation Information

Manufacturer	Tools	Color	Code
-			

#	Cat.No	Wire Size (mm ²)	Dimension (mm)					
			Bolt Size	A	B	C	R	ID
1	MC1005N	10.00	M5	26.50	12.50	9.00	13.20	4.60
2	MC1208N	120.00	M8	57.50	23.00	19.00	32.50	15.20
3	MC1210N	120.00	M10	57.50	23.00	19.00	32.50	15.20
4	MC1508N	150.00	M8	66.00	27.00	19.00	35.90	16.70
5	MC1510N	150.00	M10	66.00	27.00	19.00	35.90	16.70
6	MC1605N	16.00	M5	29.50	12.50	9.00	15.20	5.80
7	MC1810N	185.00	M10	69.50	27.00	24.50	39.40	19.20
8	MC2410N	240.00	M10	71.50	22.00	31.00	47.40	21.10
9	MC2412N	240.00	M12	77.50	28.00	31.00	47.40	21.10
10	MC2416N	240.00	M16	85.50	36.00	31.00	47.40	21.10
11	MC2505N	25.00	M5	31.50	12.50	9.00	17.20	7.00
12	MC3112N	300.00	M12	89.50	28.00	31.00	58.10	23.70
13	MC3506N	35.00	M6	36.00	15.00	11.50	19.20	8.90
14	MC5006N	50.00	M6	41.00	15.00	11.50	25.00	10.00
15	MC9508N	95.00	M8	49.50	17.00	15.50	30.80	13.50

6mm

Metric Wire Connector / KC Series Metric Terminals

6mm

Metric Wire Connector / KC Series Metric Terminals / 6mm

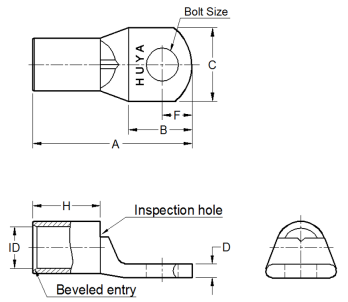

Installation Information

Manufacturer	Tools	Color	Code
-			

#	Cat.No	Wire Size (mm ²)	Bolt Size	Dimension (mm)						
				A	B	C	D	F	H	ID
1	KC0603	6	M3	19.00	8.00	7.50	1.60	3.50	7.00	3.80
2	KC0604	6	M4	20.00	9.00	7.50	1.60	4.00	7.00	3.80
3	KC0605	6	M5	23.50	12.50	10.00	1.50	6.00	7.00	3.80
4	KC0606	6	M6	24.00	13.00	11.00	1.50	6.00	7.00	3.80
5	KC0608	6	M8	28.00	17.00	12.00	1.50	8.00	7.00	3.80
6	KC0610	6	M10	32.00	21.00	14.00	1.50	10.00	7.00	3.80
7	KC0635	6	M3.5	19.00	8.00	7.50	1.60	3.50	7.00	3.80

10mm

Metric Wire Connector / KC Series Metric Terminals

10mm

Metric Wire Connector / KC Series Metric Terminals / 10mm

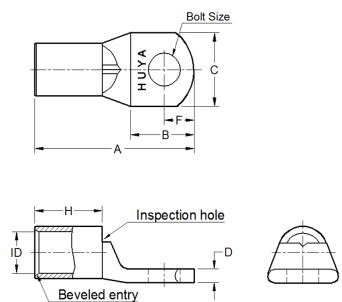

Installation Information

Manufacturer	Tools	Color	Code
-			

#	Cat.No	Wire Size (mm ²)	Bolt Size	Dimension (mm)						
				A	B	C	D	F	H	ID
1	KC1004	10.00	M4	22.00	9.00	10.00	1.90	4.00	8.00	4.60
2	KC1005	10.00	M5	25.50	12.50	10.00	1.90	6.00	8.00	4.60
3	KC1006	10.00	M6	26.00	13.00	10.00	1.90	6.00	8.00	4.60
4	KC1008	10.00	M8	30.00	17.00	13.00	1.90	8.00	8.00	4.60
5	KC1010	10.00	M10	34.00	21.00	15.00	1.90	10.00	8.00	4.60
6	KC1012	10.00	M12	39.00	26.00	18.00	1.80	12.00	8.00	4.60

16mm

Metric Wire Connector / KC Series Metric Terminals

16mm

Metric Wire Connector / KC Series Metric Terminals / 16mm

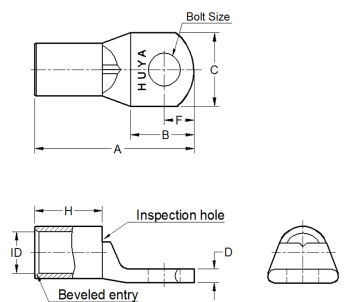

Installation Information

Manufacturer	Tools	Color	Code
-			

#	Cat.No	Wire Size (mm ²)	Bolt Size	Dimension (mm)						
				A	B	C	D	F	H	ID
1	KC1604	16.00	M4	24.00	9.00	10.60	2.00	4.00	9.50	5.50
2	KC1605	16.00	M5	27.50	12.50	10.60	2.00	6.00	9.50	5.50
3	KC1606	16.00	M6	28.00	13.00	10.60	2.00	6.00	9.50	5.50
4	KC1608	16.00	M8	32.00	17.00	13.00	2.00	8.00	9.50	5.50
5	KC1610	16.00	M10	36.00	21.00	15.00	1.80	10.00	9.50	5.50
6	KC1612	16.00	M12	41.00	26.00	18.00	1.70	12.00	9.50	5.50

25mm

Metric Wire Connector / KC Series Metric Terminals

25mm

Metric Wire Connector / KC Series Metric Terminals / 25mm

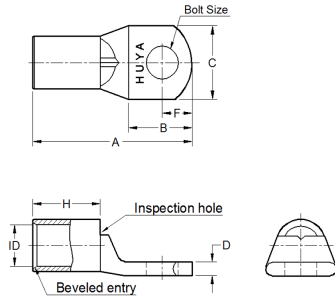

Installation Information

Manufacturer	Tools	Color	Code
-			

#	Cat.No	Wire Size (mm ²)	Bolt Size	Dimension (mm)						
				A	B	C	D	F	H	ID
1	KC2504	25.00	M4	26.00	9.00	13.20	2.00	4.00	10.00	7.10
2	KC2505	25.00	M5	29.50	12.50	13.20	2.00	6.00	10.00	7.10
3	KC2506	25.00	M6	30.00	13.00	13.20	2.00	6.00	10.00	7.10
4	KC2508	25.00	M8	34.00	17.00	14.00	1.80	8.00	10.00	7.10
5	KC2510	25.00	M10	38.00	21.00	16.00	1.80	10.00	10.00	7.10
6	KC2512	25.00	M12	43.00	26.00	18.00	1.70	12.00	10.00	7.10

35mm

Metric Wire Connector / KC Series Metric Terminals

35mm

Metric Wire Connector / KC Series Metric Terminals / 35mm

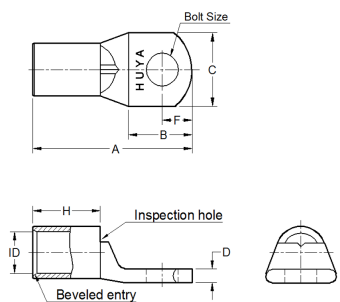

Installation Information

Manufacturer	Tools	Color	Code
-			

#	Cat.No	Wire Size (mm ²)	Bolt Size	Dimension (mm)						
				A	B	C	D	F	H	ID
1	KC3505	35.00	M5	31.50	12.50	16.00	2.70	6.00	12.00	8.50
2	KC3506	35.00	M6	32.00	13.00	16.00	2.70	6.00	12.00	8.50
3	KC3508	35.00	M8	36.00	17.00	16.00	2.70	8.00	12.00	8.50
4	KC3510	35.00	M10	40.00	21.00	17.00	2.50	10.00	12.00	8.50
5	KC3512	35.00	M12	45.00	26.00	19.00	2.40	12.00	12.00	8.50

50mm

Metric Wire Connector / KC Series Metric Terminals

50mm

Metric Wire Connector / KC Series Metric Terminals / 50mm

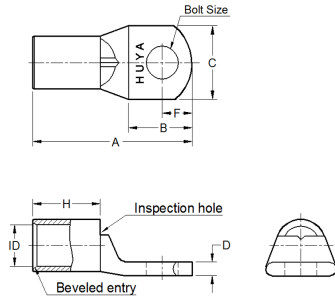

Installation Information

Manufacturer	Tools	Color	Code
-			

#	Cat.No	Wire Size (mm ²)	Bolt Size	Dimension (mm)						
				A	B	C	D	F	H	ID
1	KC5006	50.00	M6	40.00	15.00	18.70	3.00	7.00	17.00	10.00
2	KC5008	50.00	M8	42.00	17.00	18.70	3.00	8.00	17.00	10.00
3	KC5010	50.00	M10	46.00	21.00	18.70	3.00	10.00	17.00	10.00
4	KC5012	50.00	M12	51.00	26.00	20.00	3.00	12.00	17.00	10.00
5	KC5014	50.00	M14	55.00	30.00	21.00	3.00	14.00	17.00	10.00
6	KC5016	50.00	M16	59.00	34.00	23.00	2.80	16.00	17.00	10.00

70mm

Metric Wire Connector / KC Series Metric Terminals

70mm

Metric Wire Connector / KC Series Metric Terminals / 70mm

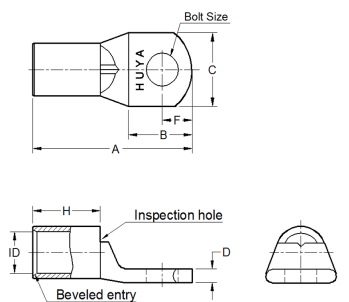

Installation Information

Manufacturer	Tools	Color	Code
-			

#	Cat.No	Wire Size (mm ²)	Bolt Size	Dimension (mm)						
				A	B	C	D	F	H	ID
1	KC7006	70.00	M6	41.00	15.00	20.70	3.00	7.00	17.50	11.30
2	KC7008	70.00	M8	43.00	17.00	20.70	3.00	8.00	17.50	11.30
3	KC7010	70.00	M10	47.00	21.00	20.70	3.00	10.00	17.50	11.30
4	KC7012	70.00	M12	52.00	26.00	20.70	3.00	12.00	17.50	11.30
5	KC7014	70.00	M14	56.00	30.00	21.00	2.90	14.00	17.50	11.30
6	KC7016	70.00	M16	60.00	34.00	23.00	2.80	16.00	17.50	11.30

95mm

Metric Wire Connector / KC Series Metric Terminals

95mm

Metric Wire Connector / KC Series Metric Terminals / 95mm

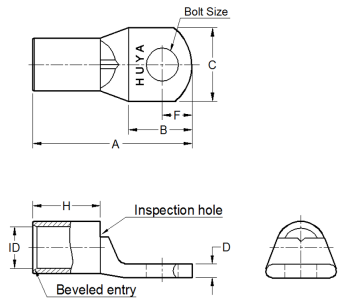

Installation Information

Manufacturer	Tools	Color	Code
-			

#	Cat.No	Wire Size (mm ²)	Bolt Size	Dimension (mm)						
				A	B	C	D	F	H	ID
1	KC9506	95.00	M6	46.00	15.00	25.00	4.00	7.00	22.00	13.40
2	KC9508	95.00	M8	48.00	17.00	25.00	4.00	8.00	22.00	13.40
3	KC9510	95.00	M10	52.00	21.00	25.00	4.00	10.00	22.00	13.40
4	KC9512	95.00	M12	57.00	26.00	25.00	4.00	12.00	22.00	13.40
5	KC9514	95.00	M14	61.00	30.00	25.00	4.00	14.00	22.00	13.40
6	KC9516	95.00	M16	65.00	34.00	25.00	4.00	16.00	22.00	13.40
7	KC9520	95.00	M20	73.00	42.00	29.00	3.80	20.00	22.00	13.40

120mm

Metric Wire Connector / KC Series Metric Terminals

120mm

Metric Wire Connector / KC Series Metric Terminals / 120mm

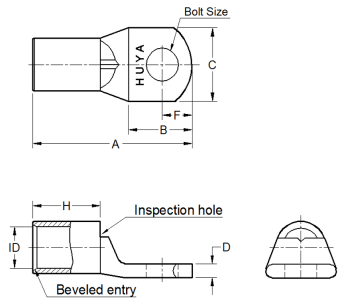

Installation Information

Manufacturer	Tools	Color	Code
-			

#	Cat.No	Wire Size (mm ²)	Bolt Size	Dimension (mm)						
				A	B	C	D	F	H	ID
1	KC1206	120.00	M6	47.00	15.00	27.50	4.00	7.00	23.00	15.00
2	KC1208	120.00	M8	49.00	17.00	27.50	4.00	8.00	23.00	15.00
3	KC1210	120.00	M10	53.00	21.00	27.50	4.00	10.00	23.00	15.00
4	KC1212	120.00	M12	58.00	26.00	27.50	4.00	12.00	23.00	15.00
5	KC1214	120.00	M14	62.00	30.00	27.50	4.00	14.00	23.00	15.00
6	KC1216	120.00	M16	66.00	34.00	27.50	4.00	16.00	23.00	15.00
7	KC1220	120.00	M20	74.00	42.00	29.00	3.90	20.00	23.00	15.00

150mm

Metric Wire Connector / KC Series Metric Terminals

150mm

Metric Wire Connector / KC Series Metric Terminals / 150mm

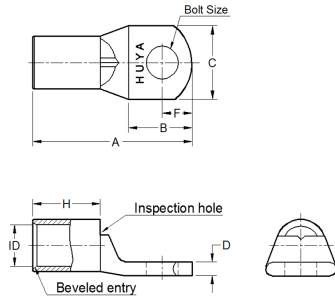

Installation Information

Manufacturer	Tools	Color	Code
-			

#	Cat.No	Wire Size (mm ²)	Bolt Size	Dimension (mm)						
				A	B	C	D	F	H	ID
1	KC1508	150.00	M8	60.00	24.00	30.50	4.50	11.00	25.00	16.50
2	KC1510	150.00	M10	60.00	24.00	30.50	4.50	11.00	25.00	16.50
3	KC1512	150.00	M12	66.00	30.00	30.50	4.50	14.00	25.00	16.50
4	KC1514	150.00	M14	70.00	34.00	30.50	4.50	16.00	25.00	16.50
5	KC1516	150.00	M16	72.00	36.00	30.50	4.50	17.00	25.00	16.50
6	KC1520	150.00	M20	78.00	42.00	30.50	4.50	20.00	25.00	16.50

185mm

Metric Wire Connector / KC Series Metric Terminals

185mm

Metric Wire Connector / KC Series Metric Terminals / 185mm

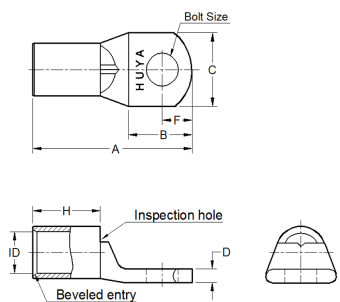

Installation Information

Manufacturer	Tools	Color	Code
-			

#	Cat.No	Wire Size (mm ²)	Bolt Size	Dimension (mm)						
				A	B	C	D	F	H	ID
1	KC1808	185.00	M8	63.00	24.00	35.00	4.80	11.00	26.00	19.00
2	KC1810	185.00	M10	63.00	24.00	35.00	4.80	11.00	26.00	19.00
3	KC1812	185.00	M12	69.00	30.00	35.00	4.80	14.00	26.00	19.00
4	KC1814	185.00	M14	73.00	34.00	35.00	4.80	16.00	26.00	19.00
5	KC1816	185.00	M16	75.00	36.00	35.00	4.80	17.00	26.00	19.00
6	KC1820	185.00	M20	81.00	42.00	35.00	4.80	20.00	26.00	19.00

240mm

Metric Wire Connector / KC Series Metric Terminals

240mm

Metric Wire Connector / KC Series Metric Terminals / 240mm

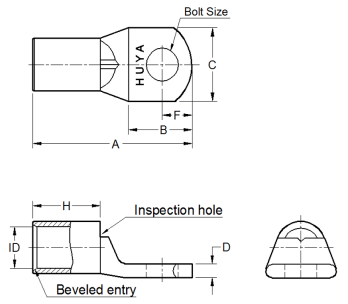

Installation Information

Manufacturer	Tools	Color	Code
-			

#	Cat.No	Wire Size (mm ²)	Bolt Size	Dimension (mm)						
				A	B	C	D	F	H	ID
1	KC2408	240.00	M8	70.00	24.00	39.00	5.90	11.00	30.50	20.80
2	KC2410	240.00	M10	70.00	24.00	39.00	5.90	11.00	30.50	20.80
3	KC2412	240.00	M12	76.00	30.00	39.00	5.90	14.00	30.50	20.80
4	KC2414	240.00	M14	80.00	34.00	39.00	5.90	16.00	30.50	20.80
5	KC2416	240.00	M16	82.00	36.00	39.00	5.90	17.00	30.50	20.80
6	KC2420	240.00	M20	88.00	42.00	39.00	5.90	20.00	30.50	20.80

300mm

Metric Wire Connector / KC Series Metric Terminals

300mm

Metric Wire Connector / KC Series Metric Terminals / 300mm

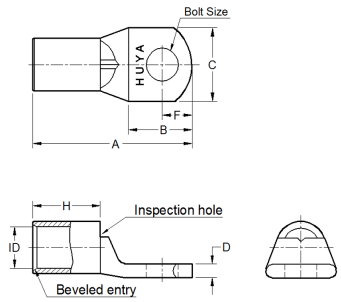

Installation Information

Manufacturer	Tools	Color	Code
-			

#	Cat.No	Wire Size (mm ²)	Bolt Size	Dimension (mm)						
				A	B	C	D	F	H	ID
1	KC3110	300.00	M10	89.00	31.00	44.00	6.80	11.00	40.00	23.50
2	KC3112	300.00	M12	92.00	34.00	44.00	6.80	14.00	40.00	23.50
3	KC3114	300.00	M14	96.00	38.00	44.00	6.80	16.00	40.00	23.50
4	KC3116	300.00	M16	99.00	41.00	44.00	6.80	19.00	40.00	23.50
5	KC3120	300.00	M20	105.00	47.00	44.00	6.80	23.00	40.00	23.50

400mm

Metric Wire Connector / KC Series Metric Terminals

400mm

Metric Wire Connector / KC Series Metric Terminals / 400mm

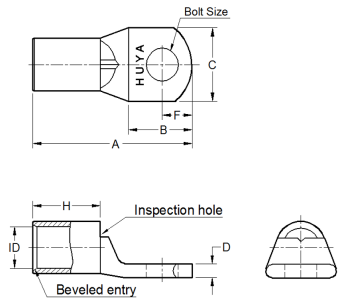

Installation Information

Manufacturer	Tools	Color	Code
-			

#	Cat.No	Wire Size (mm ²)	Bolt Size	Dimension (mm)						
				A	B	C	D	F	H	ID
1	KC4110	400.00	M10	101.00	41.00	50.00	7.70	11.00	40.00	26.80
2	KC4112	400.00	M12	101.00	41.00	50.00	7.70	14.00	40.00	26.80
3	KC4114	400.00	M14	101.00	41.00	50.00	7.70	16.00	40.00	26.80
4	KC4116	400.00	M16	101.00	41.00	50.00	7.70	19.00	40.00	26.80
5	KC4120	400.00	M20	107.00	47.00	50.00	7.70	23.00	40.00	26.80

500mm

Metric Wire Connector / KC Series Metric Terminals

500mm

Metric Wire Connector / KC Series Metric Terminals / 500mm

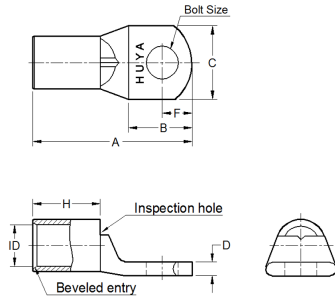

Installation Information

Manufacturer	Tools	Color	Code
-			

#	Cat.No	Wire Size (mm ²)	Bolt Size	Dimension (mm)						
				A	B	C	D	F	H	ID
1	KC5110	500.00	M10	96.00	34.00	56.00	8.90	11.00	42.00	30.10
2	KC5112	500.00	M12	103.00	41.00	56.00	8.90	14.00	42.00	30.10
3	KC5116	500.00	M16	103.00	41.00	56.00	8.90	19.00	42.00	30.10
4	KC5120	500.00	M20	109.00	47.00	56.00	8.90	23.00	42.00	30.10

630mm

Metric Wire Connector / KC Series Metric Terminals

630mm

Metric Wire Connector / KC Series Metric Terminals / 630mm

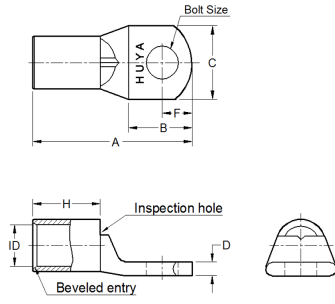

Installation Information

Manufacturer	Tools	Color	Code
-			

#	Cat.No	Wire Size (mm ²)	Bolt Size	Dimension (mm)						
				A	B	C	D	F	H	ID
1	KC6316	630.00	M16	118.00	41.00	61.00	8.90	19.00	53.00	33.10
2	KC6320	630.00	M20	124.00	47.00	61.00	8.90	23.00	53.00	33.10