

10mm Catalog

Metric Wire Connector / KC Series Metric Terminals

CATEGORY EDITION

10mm

Metric Wire Connector / KC Series Metric Terminals / 10mm

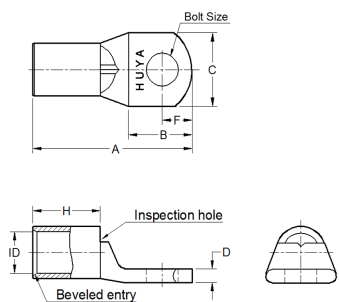

Installation Information

Manufacturer	Tools	Color	Code
-			

#	Cat.No	Wire Size (mm ²)	Bolt Size	Dimension (mm)						
				A	B	C	D	F	H	ID
1	KC1004	10.00	M4	22.00	9.00	10.00	1.90	4.00	8.00	4.60
2	KC1005	10.00	M5	25.50	12.50	10.00	1.90	6.00	8.00	4.60
3	KC1006	10.00	M6	26.00	13.00	10.00	1.90	6.00	8.00	4.60
4	KC1008	10.00	M8	30.00	17.00	13.00	1.90	8.00	8.00	4.60
5	KC1010	10.00	M10	34.00	21.00	15.00	1.90	10.00	8.00	4.60
6	KC1012	10.00	M12	39.00	26.00	18.00	1.80	12.00	8.00	4.60