

25mm Catalog

Metric Wire Connector / KC Series Metric Terminals

CATEGORY EDITION

25mm

Metric Wire Connector / KC Series Metric Terminals / 25mm

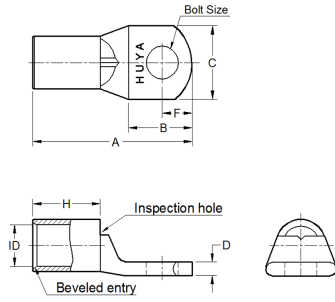

Installation Information

Manufacturer	Tools	Color	Code
-			

#	Cat.No	Wire Size (mm ²)	Bolt Size	Dimension (mm)						
				A	B	C	D	F	H	ID
1	KC2504	25.00	M4	26.00	9.00	13.20	2.00	4.00	10.00	7.10
2	KC2505	25.00	M5	29.50	12.50	13.20	2.00	6.00	10.00	7.10
3	KC2506	25.00	M6	30.00	13.00	13.20	2.00	6.00	10.00	7.10
4	KC2508	25.00	M8	34.00	17.00	14.00	1.80	8.00	10.00	7.10
5	KC2510	25.00	M10	38.00	21.00	16.00	1.80	10.00	10.00	7.10
6	KC2512	25.00	M12	43.00	26.00	18.00	1.70	12.00	10.00	7.10