

35mm Catalog

Metric Wire Connector / KC Series Metric Terminals

CATEGORY EDITION

35mm

Metric Wire Connector / KC Series Metric Terminals / 35mm

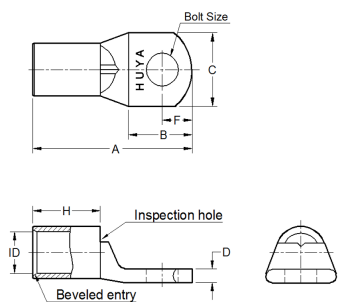

Installation Information

Manufacturer	Tools	Color	Code
-			

#	Cat.No	Wire Size (mm ²)	Bolt Size	Dimension (mm)						
				A	B	C	D	F	H	ID
1	KC3505	35.00	M5	31.50	12.50	16.00	2.70	6.00	12.00	8.50
2	KC3506	35.00	M6	32.00	13.00	16.00	2.70	6.00	12.00	8.50
3	KC3508	35.00	M8	36.00	17.00	16.00	2.70	8.00	12.00	8.50
4	KC3510	35.00	M10	40.00	21.00	17.00	2.50	10.00	12.00	8.50
5	KC3512	35.00	M12	45.00	26.00	19.00	2.40	12.00	12.00	8.50