

50mm Catalog

Metric Wire Connector / KC Series Metric Terminals

CATEGORY EDITION

50mm

Metric Wire Connector / KC Series Metric Terminals / 50mm

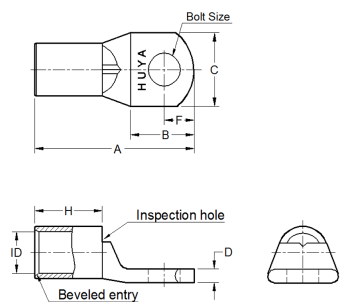

Installation Information

Manufacturer	Tools	Color	Code
-			

#	Cat.No	Wire Size (mm ²)	Bolt Size	Dimension (mm)						
				A	B	C	D	F	H	ID
1	KC5006	50.00	M6	40.00	15.00	18.70	3.00	7.00	17.00	10.00
2	KC5008	50.00	M8	42.00	17.00	18.70	3.00	8.00	17.00	10.00
3	KC5010	50.00	M10	46.00	21.00	18.70	3.00	10.00	17.00	10.00
4	KC5012	50.00	M12	51.00	26.00	20.00	3.00	12.00	17.00	10.00
5	KC5014	50.00	M14	55.00	30.00	21.00	3.00	14.00	17.00	10.00
6	KC5016	50.00	M16	59.00	34.00	23.00	2.80	16.00	17.00	10.00