

70mm Catalog

Metric Wire Connector / KC Series Metric Terminals

CATEGORY EDITION

70mm

Metric Wire Connector / KC Series Metric Terminals / 70mm

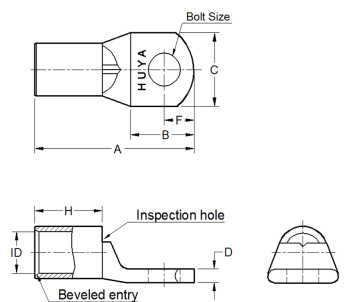

Installation Information

Manufacturer	Tools	Color	Code
-			

#	Cat.No	Wire Size (mm ²)	Bolt Size	Dimension (mm)						
				A	B	C	D	F	H	ID
1	KC7006	70.00	M6	41.00	15.00	20.70	3.00	7.00	17.50	11.30
2	KC7008	70.00	M8	43.00	17.00	20.70	3.00	8.00	17.50	11.30
3	KC7010	70.00	M10	47.00	21.00	20.70	3.00	10.00	17.50	11.30
4	KC7012	70.00	M12	52.00	26.00	20.70	3.00	12.00	17.50	11.30
5	KC7014	70.00	M14	56.00	30.00	21.00	2.90	14.00	17.50	11.30
6	KC7016	70.00	M16	60.00	34.00	23.00	2.80	16.00	17.50	11.30