

95mm Catalog

Metric Wire Connector / KC Series Metric Terminals

CATEGORY EDITION

95mm

Metric Wire Connector / KC Series Metric Terminals / 95mm

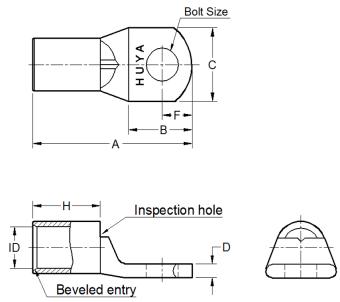

Installation Information

Manufacturer	Tools	Color	Code
-			

#	Cat.No	Wire Size (mm ²)	Bolt Size	Dimension (mm)						
				A	B	C	D	F	H	ID
1	KC9506	95.00	M6	46.00	15.00	25.00	4.00	7.00	22.00	13.40
2	KC9508	95.00	M8	48.00	17.00	25.00	4.00	8.00	22.00	13.40
3	KC9510	95.00	M10	52.00	21.00	25.00	4.00	10.00	22.00	13.40
4	KC9512	95.00	M12	57.00	26.00	25.00	4.00	12.00	22.00	13.40
5	KC9514	95.00	M14	61.00	30.00	25.00	4.00	14.00	22.00	13.40
6	KC9516	95.00	M16	65.00	34.00	25.00	4.00	16.00	22.00	13.40
7	KC9520	95.00	M20	73.00	42.00	29.00	3.80	20.00	22.00	13.40