

240mm Catalog

Metric Wire Connector / KC Series Metric Terminals

CATEGORY EDITION

240mm

Metric Wire Connector / KC Series Metric Terminals / 240mm

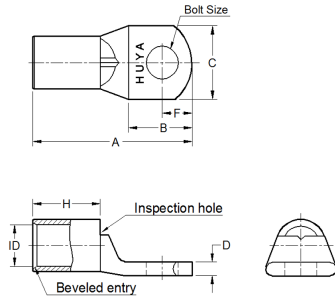

Installation Information

Manufacturer	Tools	Color	Code
-			

#	Cat.No	Wire Size (mm ²)	Bolt Size	Dimension (mm)						
				A	B	C	D	F	H	ID
1	KC2408	240.00	M8	70.00	24.00	39.00	5.90	11.00	30.50	20.80
2	KC2410	240.00	M10	70.00	24.00	39.00	5.90	11.00	30.50	20.80
3	KC2412	240.00	M12	76.00	30.00	39.00	5.90	14.00	30.50	20.80
4	KC2414	240.00	M14	80.00	34.00	39.00	5.90	16.00	30.50	20.80
5	KC2416	240.00	M16	82.00	36.00	39.00	5.90	17.00	30.50	20.80
6	KC2420	240.00	M20	88.00	42.00	39.00	5.90	20.00	30.50	20.80