

THE INFORMATION ON THIS DRAWING IS THE PROPERTY OF CELESTRA, IS DISCLOSED IN CONFIDENCE AND NOT TO BE REPRODUCED, USED OR DISCLOSED EXCEPT FOR WHICH FURNISHED.

CELESTRA CAT.NO	Wire Size (mm ²)	Bolt Size	Dimension (mm)						
			A	B	C	D	F	H	ID
KC1012	10.00	M12	39.00	26.00	18.00	1.80	12.00	8.00	4.60

NOTE:
 ALL DIMENSIONS ARE IN MILLIMETER UNLESS OTHERWISE SPECIFIED.
 MATERIAL: HIGH CONDUCTIVITY WROUGHT COPPER
 FINISH: ELECTRO-TIN PLATE

INSTALLATION GUIDE
 DIE CODE = __
 DIE COLOR = __

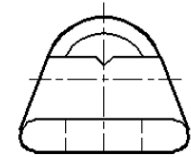
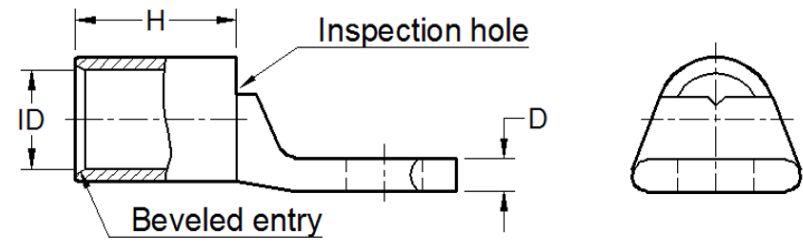
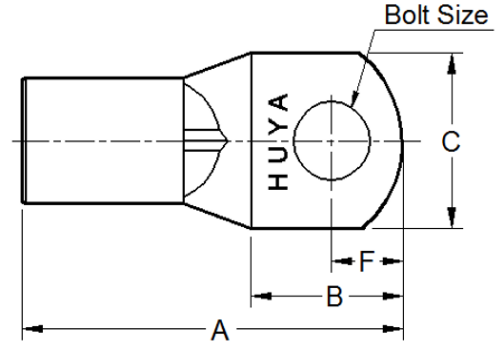

REV	DATE	DWN	CHK	DESCRIPTION	ECN
00	20-Apr-26	Ruby Feng	Sinia Qiu	Celestra Standards Spec. Initialed.	

HUYA [®] www.huyaco.com		CELESTRA CORPORATION 76. Huancun Rd. Zhongcun Town. Panyu Dist. Guangzhou 511495.	
TITLE WIRE CONNECTORS AND SOLDERING LUGS FOR CODE AND FLEX CABLE			
MATERIAL HIGH CONDUCTIVITY WROUGHT COPPER.	PRT. NO. KC1012	SCALE NTS	THIRD ANGLE PROJECTION
FINISH ELECTRO-TIN PLATE.	DWG. NO. 186-cp5256	UNIT INCH	