

4

3

2

1

THE INFORMATION ON THIS DRAWING IS THE PROPERTY OF CELESTRA, IS DISCLOSED IN CONFIDENCE AND NOT TO BE REPRODUCED, USED OR DISCLOSED EXCEPT FOR WHICH FURNISHED.

CELESTRA CAT.NO	WIRE SIZE	BOLT SIZE	Dimension (in)						
			B	C	D	F	ID	OD	R
J10AN2014F	2/0	1/4	0.94	0.84	0.13	0.41	0.44	0.57	0.69

- NOTE:
1. ALL DIMENSIONS ARE IN INCHES UNLESS OTHERWISE SPECIFIED.
 2. ALL DA,DB,LA,LB,WP,AL,AS AND J SERIES OF CAT.NO.S ARE LISTED BY "UNDERWRITERS INC." AND "CSA" FOR USE ON CODE WIRES AND FLEX/24 STRANDED CABLES.

PRE-FIX CAT.NO.WITH "L" HAS NOT PEEP HOLE UNLESS OTHERWISE SPECIFIED IN THE SUFFIX OF THE CAT.NO. WITH "P".

MATERIAL: HIGH CONDUCTIVITY WROUGHT COPPER

FINISH: ELECTOR-TIN PLATE UNLESS OTHERWISE SPECIFIED PER MIL - T -16366.
SUFFIX CAT.NO.WITH "SP" FOR SILVER.

INSTALLATION GUIDE

DIE CODE = __
DIE COLOR = __

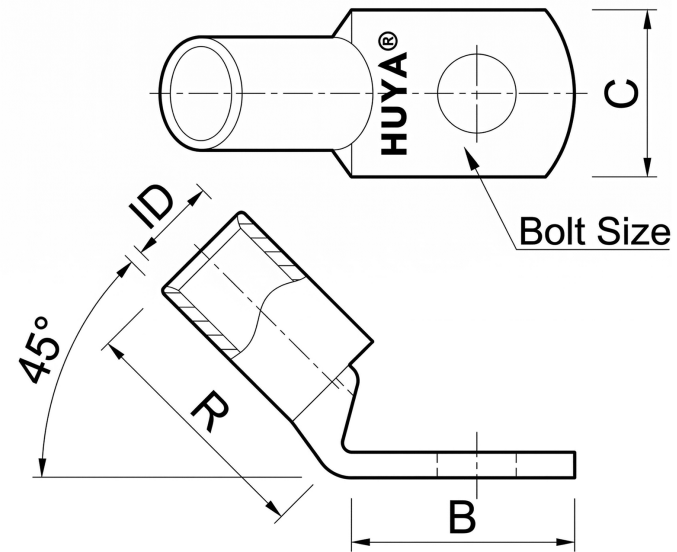

NEBS³



CE

HUYA®
www.huyaco.com

CELESTRA CORPORATION

76. Huancun Rd. Zhongcun Town.
Panyu Dist. Guangzhou 511495.

TITLE WIRE CONNECTORS AND SOLDERING
LUGS FOR CODE AND FLEX CABLE

MATERIAL	PRT. NO. J10AN2014F	SCALE NTS	THIRD ANGLE PROJECTION
FINISH	DWG. NO. 186-cp5400	UNIT INCH	

REV	DATE	DWN	CHK	DESCRIPTION	ECN
00	08-Apr-26	Ruby Feng	Sinia Qiu	Celestra Standards Spec. Initialed.	

4

3

2

1