

THE INFORMATION ON THIS DRAWING IS THE PROPERTY OF CELESTRA, IS DISCLOSED IN CONFIDENCE AND NOT TO BE REPRODUCED, USED OR DISCLOSED EXCEPT FOR WHICH FURNISHED.

CELESTRA CAT.NO	WIRE SIZE	BOLT SIZE	Dimension (in)						
			B	C	D	F	ID	OD	R
J40AN2512A	250 MCM	1/2	1.24	1.14	0.14	0.56	0.63	0.77	0.96

- NOTE:
1. ALL DIMENSIONS ARE IN INCHES UNLESS OTHERWISE SPECIFIED.
 2. ALL DA,DB,LA,LB,WP,AL,AS AND J SERIES OF CAT.NO.S ARE LISTED BY "UNDERWRITERS INC." AND "CSA" FOR USE ON CODE WIRES AND FLEX/24 STRANDED CABLES.

PRE-FIX CAT.NO.WITH "L" HAS NOT PEEP HOLE UNLESS OTHERWISE SPECIFIED IN THE SUFFIX OF THE CAT.NO. WITH "P".

MATERIAL: HIGH CONDUCTIVITY WROUGHT COPPER

FINISH: ELECTOR-TIN PLATE UNLESS OTHERWISE SPECIFIED PER MIL - T - 16366.
SUFFIX CAT.NO.WITH "SP" FOR SILVER.

INSTALLATION GUIDE

DIE CODE = __
DIE COLOR = __

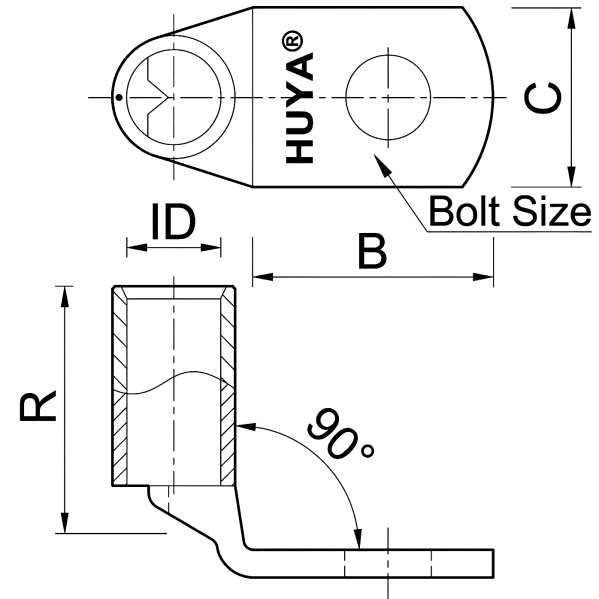

HUYA®
www.huyaco.com

CELESTRA CORPORATION
76. Huancun Rd. Zhongcun Town.
Panyu Dist. Guangzhou 511495.

TITLE WIRE CONNECTORS AND SOLDERING LUGS FOR CODE AND FLEX CABLE

REV	DATE	DWN	CHK	DESCRIPTION	ECN
00	04-Apr-26	Ruby Feng	Sinia Qiu	Celestra Standards Spec. Initialed.	

MATERIAL	PRT. NO.	SCALE	THIRD ANGLE PROJECTION
	J40AN2512A	NTS	
FINISH	DWG. NO.	UNIT	
	186-cp5461	INCH	