

THE INFORMATION ON THIS DRAWING IS THE PROPERTY OF CELESTRA, IS DISCLOSED IN CONFIDENCE AND NOT TO BE REPRODUCED, USED OR DISCLOSED EXCEPT FOR WHICH FURNISHED.

CELESTRA CAT.NO	Wire Size (mm ²)	Dimension (mm)					
		Bolt Size	A	B	C	R	ID
MC1006-252	10.00	M6	45.00	15.80	11.00	28.80	4.50

NOTE:
 ALL DIMENSIONS ARE IN MILLIMETER UNLESS OTHERWISE SPECIFIED.
 MATERIAL: HIGH CONDUCTIVITY WROUGHT COPPER
 FINISH: ELECTRO-TIN PLATE

INSTALLATION GUIDE
 DIE CODE = 2
 DIE COLOR = --

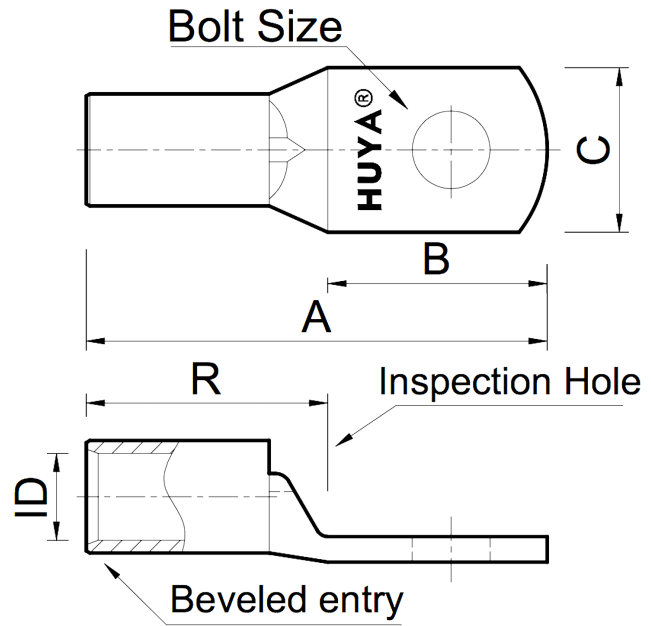

00	20-Apr-26	Ruby Feng	Sinia Qiu	Celestra Standards Spec. Initialed.	
REV	DATE	DWN	CHK	DESCRIPTION	ECN

HUYA® www.huyaco.com		CELESTRA CORPORATION 76. Huancun Rd. Zhongcun Town. Panyu Dist. Guangzhou 511495.	
TITLE WIRE CONNECTORS AND SOLDERING LUGS FOR CODE AND FLEX CABLE			
MATERIAL HIGH-CONDUCTIVITY WROUGHT COPPER	PRT. NO. MC1006-252	SCALE NTS	THIRD ANGLE PROJECTION
FINISH ELECTRO TIN PLATE	DWG. NO. 186-cp5496	UNIT INCH	