

THE INFORMATION ON THIS DRAWING IS THE PROPERTY OF CELESTRA, IS DISCLOSED IN CONFIDENCE AND NOT TO BE REPRODUCED, USED OR DISCLOSED EXCEPT FOR WHICH FURNISHED.

CELESTRA CAT.NO	Wire Size (mm ²)	Dimension (mm)				
		Bolt Size	B	C	R	ID
MC3506A-30	35.00	M6	24.50	18.00	29.00	9.00

NOTE:
 ALL DIMENSIONS ARE IN MILLIMETER UNLESS OTHERWISE SPECIFIED.
 MATERIAL: HIGH CONDUCTIVITY WROUGHT COPPER
 FINISH: ELECTRO-TIN PLATE

INSTALLATION GUIDE
 DIE CODE = 7
 DIE COLOR = --

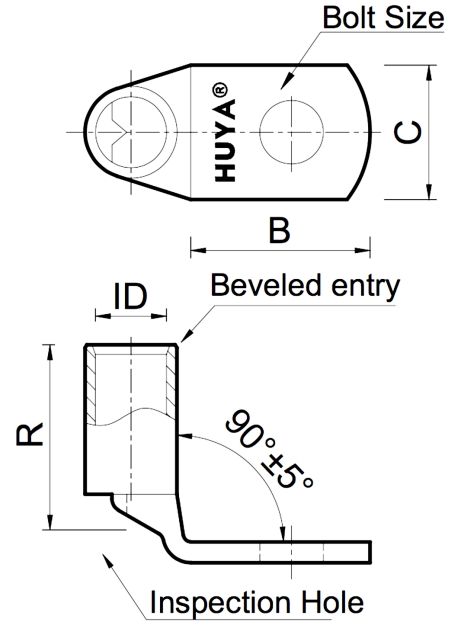

HUYA®
 www.huyaco.com

CELESTRA CORPORATION
 76. Huancun Rd. Zhongcun Town.
 Panyu Dist. Guangzhou 511495.

TITLE WIRE CONNECTORS AND SOLDERING LUGS FOR CODE AND FLEX CABLE

00	20-Apr-26	Ruby Feng	Sinia Qiu	Celestra Standards Spec. Initialed.	
REV	DATE	DWN	CHK	DESCRIPTION	ECN

MATERIAL	HIGH-CONDUCTIVITY WROUGHT COPPER	PRT. NO.	MC3506A-30	SCALE	NTS	THIRD ANGLE PROJECTION
FINISH	ELECTRO TIN PLATE	DWG. NO.	186-cp6227	UNIT	INCH	

