

THE INFORMATION ON THIS DRAWING IS THE PROPERTY OF CELESTRA, IS DISCLOSED IN CONFIDENCE AND NOT TO BE REPRODUCED, USED OR DISCLOSED EXCEPT FOR WHICH FURNISHED.

CELESTRA CAT.NO	Wire Size (mm ²)	Dimension (mm)				
		Bolt Size	B	C	R	ID
MC2420A-40	240.00	M20	45.50	39.00	51.30	21.00

NOTE:

ALL DIMENSIONS ARE IN MILLIMETER UNLESS OTHERWISE SPECIFIED.

MATERIAL: HIGH CONDUCTIVITY WROUGHT COPPER

FINISH: ELECTRO-TIN PLATE

INSTALLATION GUIDE

DIE CODE = 48

DIE COLOR = --

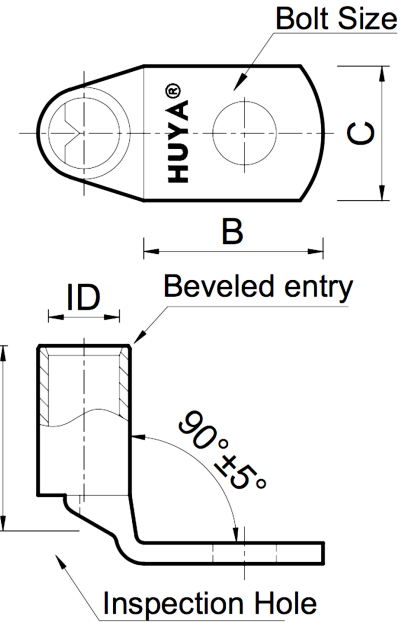

HUYA[®]
www.huyaco.com

CELESTRA CORPORATION
76. Huancun Rd. Zhongcun Town.
Panyu Dist. Guangzhou 511495.

TITLE WIRE CONNECTORS AND SOLDERING LUGS FOR CODE AND FLEX CABLE

REV	DATE	DWN	CHK	DESCRIPTION	ECN
00	20-Apr-26	Ruby Feng	Sinia Qiu	Celestra Standards Spec. Initialed.	

MATERIAL	HIGH-CONDUCTIVITY WROUGHT COPPER	PRT. NO.	MC2420A-40	SCALE	NTS	THIRD ANGLE PROJECTION
FINISH	ELECTRO TIN PLATE	DWG. NO.	186-cp6324	UNIT	INCH	

